

F4200N.2 SERIES ROBOT OPERATING MANUAL



THIS PAGE INTENTIONALLY LEFT BLANK

Table of Contents

SECTION 1: Introduction.....	7
1 Safety Precautions	8
2 Package Contents.....	9
3 Connector and Switch Locations.....	10
SECTION 2: Setup	12
1 Unpacking the Robot.....	13
2 Remove Foaming Package	13
3 Setup	14
SECTION 3: Teaching Overview.....	16
1 Teaching Overview	17
2 Using the Teach Pendant	19
2.1 Key Selection	19
2.2 Key Assignments	20
2.3 Navigation Menu.....	22
2.4 Jogging.....	22
2.5 Data Entry	22
2.6 Running a Program	23
3 Teach Box Key Assignments.....	23
4 Point Type & Function Summary.....	27
4.1 Point Menu.....	27
4.2 Setup Menu	29
4.3 Menu 1	32
4.4 Utility Menu	33
4.5 Menu 2	34
SECTION 4: Programming Example.....	35
1 Programming Example	36
2 Good Programming Practices	39
3 Editing a Program	39
3.1 Changing a Point's XYZ location	39
3.2 Insert / Delete an Instruction	40
4 Changing the Program Number.....	40
5 Changing from Teach Mode to Run Mode	40
SECTION 5: Point Type & Function Reference	41
1 Point Menu.....	42
1.1 Dispense Dot	42
1.2 Line Start.....	42
1.3 Line Passing	43
1.4 Circle	43
1.5 Arc Point	45
1.6 Line End.....	45
1.7 End Program.....	45
1.8 Dispense ON / OFF.....	46

1.9	Goto Address.....	46
1.10	Step & Repeat X.....	47
1.11	Step & Repeat Y.....	51
1.12	Brush Area	52
1.13	Call Subroutine.....	58
1.14	Call Program	59
1.15	Set I/O	59
1.16	Wait Point	59
1.17	Stop Point.....	59
1.18	Home Point	60
1.19	Loop Address	60
1.20	Dummy Point	60
1.21	Initialize	60
1.22	Label.....	60
1.23	Blend Point.....	61
2	Setup Menu	61
2.1	Line Speed.....	61
2.2	Line Dispense Setup.....	62
2.3	Point Dispense Setup.....	63
2.4	Dispense End Setup.....	63
2.5	Z Clearance	64
2.6	X/Y Move Speed.....	65
2.7	Z Move Speed	65
2.8	Home Position.....	65
2.9	Adjust Position	66
2.10	Retract Setup	68
2.11	Quickstep	70
2.12	Auto Purge Setup	70
2.13	ESTOP Output	71
2.14	Acceleration	71
2.15	Pause Status.....	71
2.16	Language.....	71
2.17	Tip Detect Position.....	72
2.18	Tip Detect Offset.....	73
2.19	Running Home First.....	75
2.20	Pre Dispense Wait Time.....	75
2.21	Circle Dispense Setup	76
2.22	Dispense Outport.....	76
2.23	Tip Search	77
2.24	Tip Search Ext. Trigger.....	77
2.25	Soft ORG Point	77
3	Menu 1.....	78
3.1	Group Edit.....	78
3.2	Expand Step & Repeat	85
3.3	Program Name	86
3.4	Z Axis Limit.....	86
3.5	Initial IO	86
3.6	Debug Speed	87
3.7	Utility Menu	87
3.8	Run Mode.....	87
3.9	Resume Program	87
3.10	Jog Speed	87
3.11	Relocate Data	88
3.12	Move Z Lifting.....	89
3.13	Z Lifting Length.....	90
3.14	Adjust Origin.....	90
4	Utility Menu	92
4.1	Program.....	92

4.2	Memory	92
4.3	Teach Pendant	92
4.4	Re-rocate Data.....	93
4.5	Lock	94
4.6	Password Setup	94
4.7	Cycle Counter.....	95
4.8	Key Beep.....	95
4.9	Test Function.....	95
4.10	USB	97
4.11	Remote Command.....	102
4.12	Program Capacity.....	102
4.13	Online Signal.....	103
4.14	Bar Code Reader	104
5	Menu 2.....	109
5.1	Numerical Move.....	109
5.2	Save Temp Point	109
5.3	Retrieve Temp Point.....	109
5.4	Undo Program	109
5.5	Redo Program.....	109
5.6	Debug Program	109
5.7	Home Position.....	109
5.8	System Information	109
5.9	Execute Point	110
5.10	Cycle Time	110
SECTION 6: Sample Programs		111
1	Dots, Lines and Arcs – Sample Program.....	112
2	Brush Area – Sample Program	114
3	Step & Repeat – Sample Program	115
4	Input / Output Signal Processing – Sample Program	117
SECTION 7: Error Messages and Specifications		119
1	Error Messages	120
1.1	Point Closed Error.....	120
1.2	Need Line Start Point	120
1.3	Need Step & Repeat	120
1.4	Unlock Program	121
1.5	Address Over Memory	121
1.6	Move Over Memory.....	121
1.7	System Error.....	121
2	I/O Specifications.....	122
2.1	Dispenser Connector:	122
2.2	Ext. Control Connector:	123
2.3	Output Signals.....	124
2.4	Input Signals.....	126
2.5	Input / Output Schematic.....	127
2.6	Input / Output Power Specifications	128
3	System Specifications	129
4	Machine Dimensions	130
4.1	Work Table Dimensions.....	131
4.2	Z-Axis Fixing Head Dimensions.....	131
4.3	X-Axis Sliding Plate Dimensions.....	132
SECTION 8: Maintenance and Periodic Inspection		133

1	Check Cycles and Methods.....	134
1.1	General Consideration.....	134
1.2	Check Cycles and Points.....	134
1.3	Check Methods.....	135
2	Greasing Procedure.....	136
2.1	Grease Type and Greasing Interval.....	136
2.2	Accessing Parts to be Greased.....	136





SECTION 1: Introduction



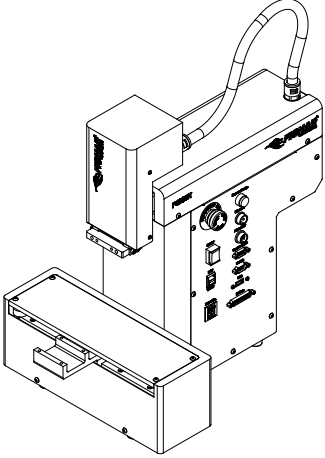
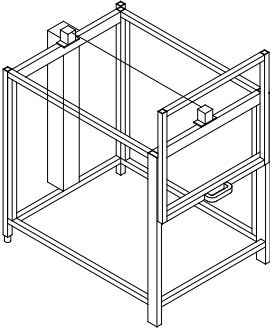
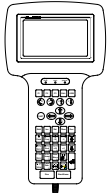

1 *Safety Precautions*

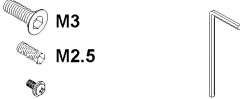
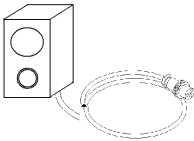
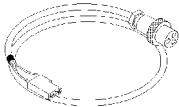
- 1.1 **In order to meet the requirements of the European Community (CE) safety directives, the robot must be placed in an enclosure supplied by Fisnar Inc. distributors.** The enclosure will prevent the operator from entering the robot's work area and will generate an emergency stop signal if the enclosure's door switch is opened while the robot is running.
- 1.2 Make sure the robot and accessories are connected to a properly grounded power source.
- 1.3 Do not drop or spill foreign objects or material such as screws or liquids into the robot.
- 1.4 Do not touch any moving parts while the robot is running.
- 1.5 Loading and unloading of parts and material must be done when the robot is not running.
- 1.6 Changing of fixtures or tooling must be done with the power source disconnected.
- 1.7 The robot should only be operated in an environment of 0 to 40 degrees centigrade and humidity of 20 to 95 percent with no condensation.
- 1.8 Do not store or install the robot in an area where it is exposed to direct sunlight.
- 1.9 Do not operate the robot where electrical noise is present.
- 1.10 Only use a neutral detergent for cleaning. Do not use alcohol, benzene or thinner.

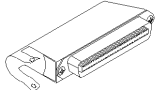
2 Package Contents

In addition to this operating manual, the following items should be included with the robot:

 <p>Main Unit</p>	 <p>Enclosure (CE Units Only – NOT INCLUDED)</p>
 <p>Teach Pendant</p>	 <p>Barrel Holder</p>
 <p>USB Drive</p>	 <p>Spare Screws and Hex Key</p>
 <p>Start / Stop Box (optional)</p>	 <p>Dispenser Cable</p>
 <p>Power Cor</p>	 <p>I/O Port Connector</p>

 <p>EXT. Port Connector</p>	 <p>Shorted EXT. Port Connector</p>
 <p>Worktable Locating Studs</p>	 <p>Tip Locators for Barrel Holder</p>

Your system may also include other optional accessories.
 If any of the above items are missing, please contact the supplier.

3 Connector and Switch Locations

3.1 Right Side View

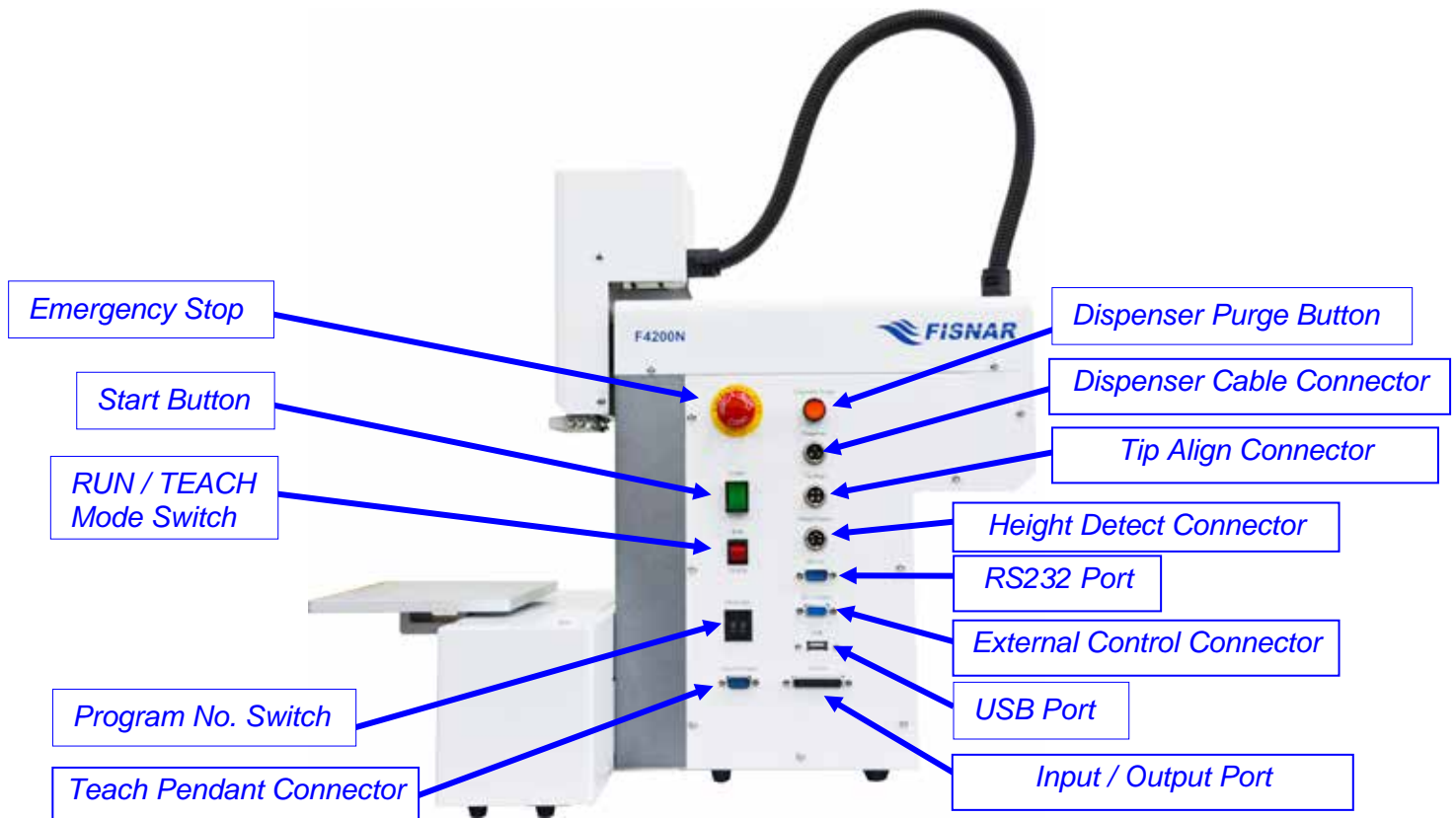

3.2 Left Side View

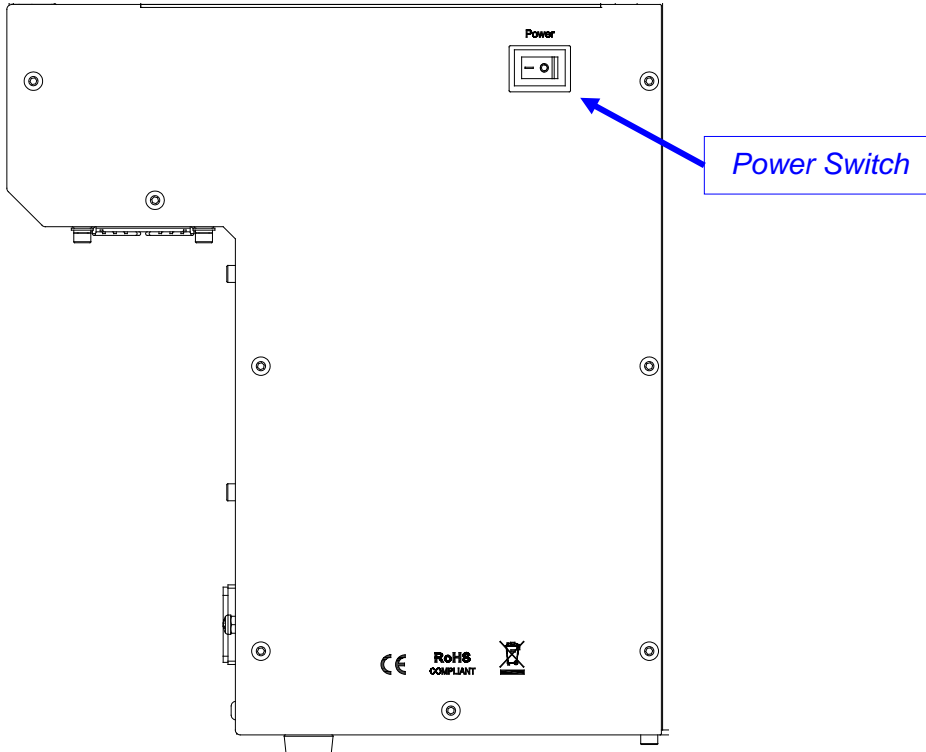

SECTION 2: Setup

1 *Unpacking the Robot*

- Unpacking the robot will require a minimum of two people. Do not attempt to lift the robot without assistance.
- Always lift the robot from the base. Never lift the robot from the cross member.
- Remove all accessories from the shipping package before attempting to remove the robot.
- Place the robot on a stable workbench.
- Do not discard the packing material or the robot's shipping bracket as these items may be needed if the robot is shipped or moved in the future.

2 *Remove Foaming Package*

All units are shipped from the factory with Foaming Covers installed. The shipping Foaming Covers secure the worktable to Y Axis and X/Z head to prevent movement and damage during shipment.

Remove the shipping Foaming Covers removing the secured tapes.
Keep the Foaming Covers and packages in a safe place for future use.

3 Setup

The F4200N series robots are available in many different configurations. The configuration of each machine and the accessories used with each system will depend on the customer's application.

The steps required to setup a system using a 30 cc or 55 cc barrel and a DC100 dispensing controller are described below.

- 3.1. If the system is being used in the European Community, the robot must be placed in a suitable CE compliant safety enclosure. The enclosure will prevent the operator from entering the robot's work area and will generate an emergency stop signal if the enclosure's door switch or light curtain is activated while the robot is running. Connect the external start / stop box and door switch or light curtain to the Ext. Control connector on the main unit. For further information, see **SECTION 7:2.1 Ext. Control Connector**.

If an enclosure is NOT being used, the enclosure door switch can be bypassed by connecting the plug labeled SHORTED (included in the robot accessories box) to the Ext. Control Connector.

- 3.2. Standard systems are shipped with a barrel holder, which can be mounted on the Z-Axis head of the robot. The barrel holder will hold a 30 cc or 55 cc barrel on the robot's head. Optional mounting brackets are available as a replacement for the barrel holder if the application so requires.

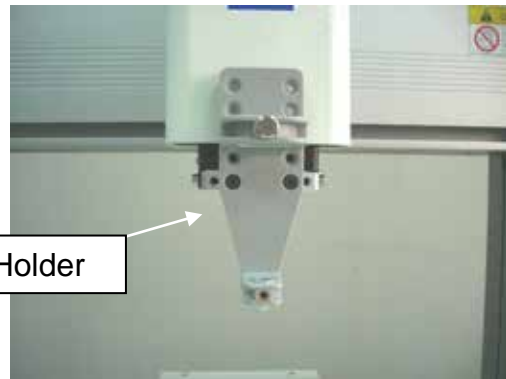

- 3.3. Mount the barrel holder or valve holder on the Z axis head as shown, using two screws. The barrel holder has several sets of mounting holes to allow it to be mounted at four different heights. Choose mounting holes which give maximum work piece clearance but allow the tip to reach all areas on the work piece where dispensing is required.

- 3.4. The dispenser, such as the DC100, is connected to the robot via the dispenser interface cable. Connect the female round connector of the dispenser interface cable to the DISPENSER connector on the robot.

Connect the female round connector from the other end of the dispenser interface cable to the FOOT PEDAL connector at the back side of the dispenser.

- 3.5. Connect the male end of the barrel adapter assembly (supplied separately) to the air output connector on the front side of the DC100.

Connect the barrel adapter end of the barrel adapter assembly to a 30 cc or 55 cc barrel of material. Connect the appropriate luer lock dispensing tip to the end of the barrel. Place the barrel in the barrel holder on the robot's Z head.

Detailed instructions for setting up the DC100 dispenser can be found in the manual provided with the DC100.

- 3.6. For normal operation, the DC100 dispenser should be put into manual mode.
- 3.7. Connect the Teach Pendant cable to the Teach Pendant connector on the robot.
- 3.8. Connect the power cord of the DC100 to the back side of the dispenser.
- 3.9. Connect the power cord of the robot to the power socket on the robot.
- 3.10. Tie back all cables and air lines so that they will not interfere with the robot's motion when the robot is operating. Be sure that the cables and air lines do not restrict the motion of the robot's head and of the robot's table and make sure that they cannot become jammed as the robot moves through the work area.

Note that this unit ships with a Shorted External Control Connector. This is not connected when shipped. Unless this is plugged in, the Teach Pendant will display an EMG ERROR (Emergency Stop). Please insert the Shorted Connector.

SECTION 3: Teaching Overview

1 Teaching Overview

A program consists of a series of instructions stored in the main unit memory. Each instruction is stored in a numbered memory address. A memory address may record a point location, with an X, Y, and Z axis value and point type or it may store an instruction which sets a parameter, such as a dispensing time or line speed.

When the program is executed, the robot will step through each memory address in sequence and execute the instruction found there. If the memory address contains a point location, the robot will move the X, Y, and Z axes to that location. Depending on the type of point registered at that location, the robot may also perform other functions, such as turn the dispenser on or off.

The most commonly used point types are Dispense Dot, Line Start, Line Passing, Arc Point, and Line End.

To program the robot to dispense a 'dot' of material, the dispensing tip must be jogged to the desired XYZ location, then that location is registered as a DISPENSE DOT point type by pressing the appropriate keys on the Teach Pendant.



To program the robot to dispense a bead of material along a linear path, the XYZ location of the start of the line is registered as a LINE START point type. The locations where the tip changes direction are registered as LINE PASSING points. The end of the line is registered as a LINE END point:

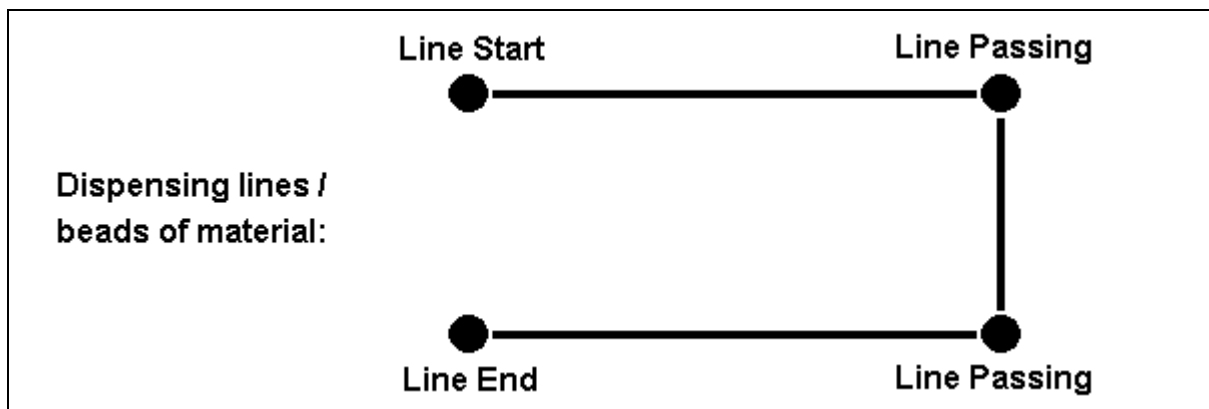

To dispense a bead of material in an arc, the XYZ location of the start of the line is registered as a LINE START point type. The high point of the arc is registered as an ARC POINT. The end of the arc is registered as a LINE END point.

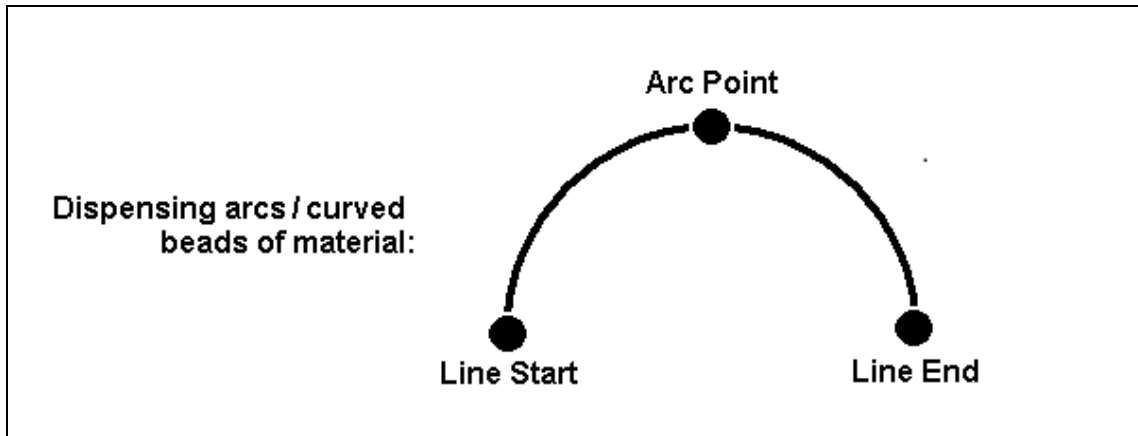

Lines and arcs can also be combined to dispense a bead of material along a complex path:

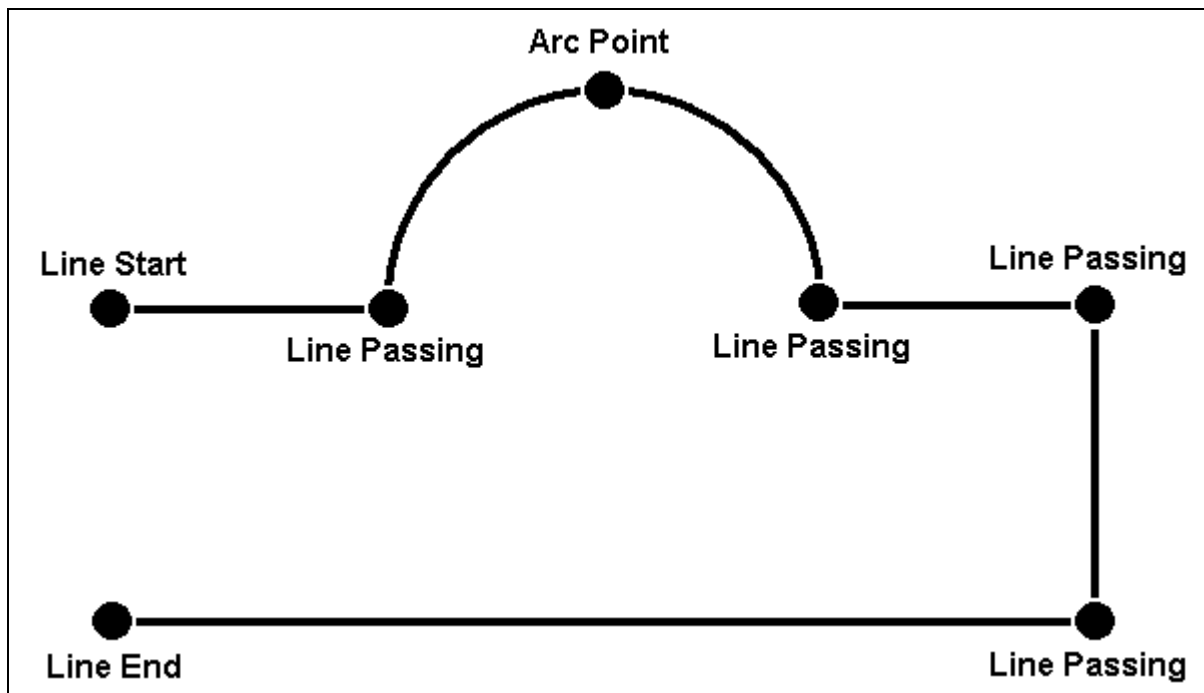

Once the required point locations for your program have been taught, the teach pendant is no longer required. The unit can be switched to RUN mode and operated using the buttons and switches on the main unit control panel.

2 Using the Teach Pendant

The teach pendant enables the user to jog robot to input program data.

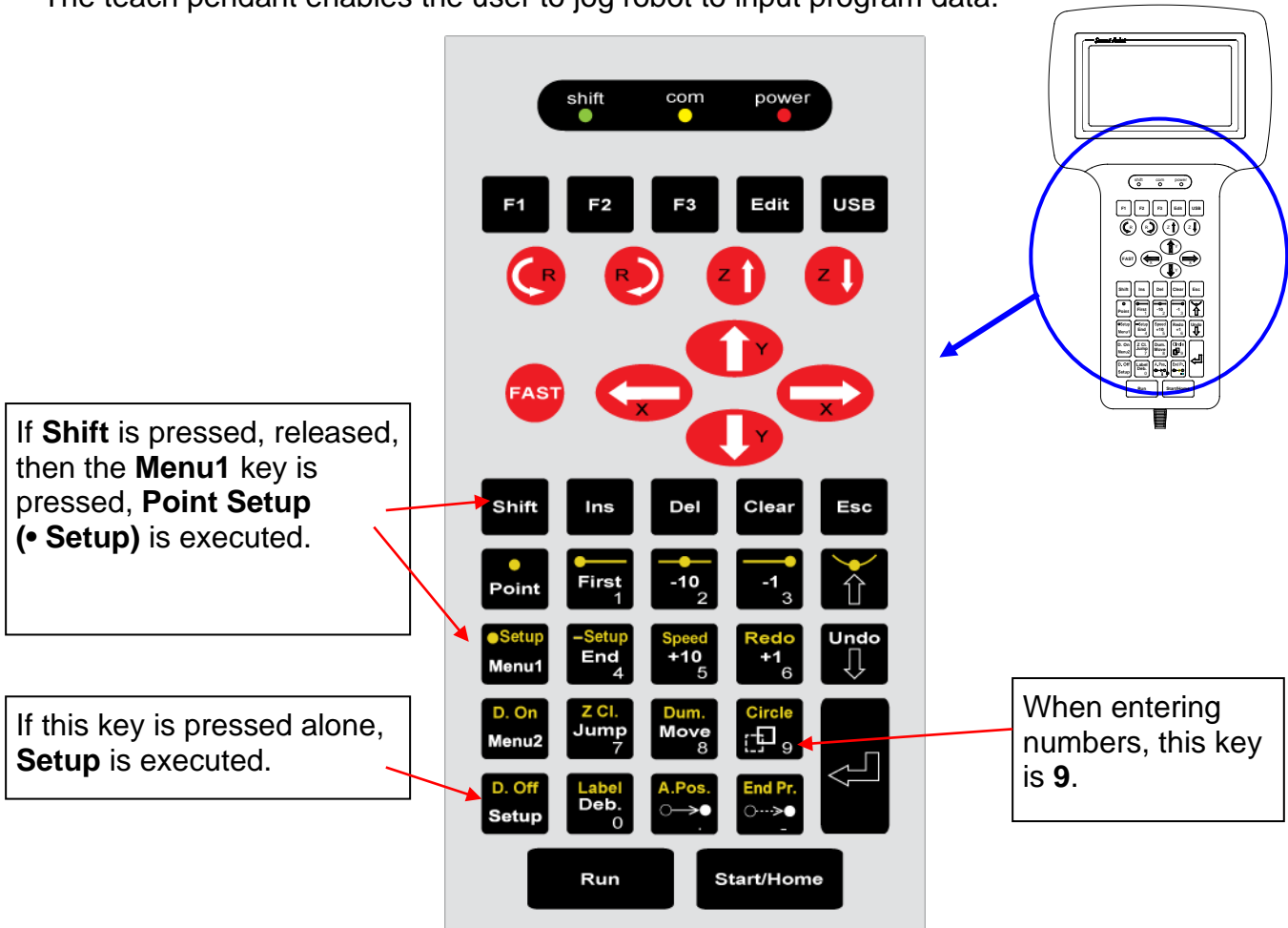











2.1 Key Selection





There are several functions assigned to most keys on the Teach pendant. When a key is pressed alone, the function shown in the white colored area on the key is executed. For example, **MENU 1**, **MENU 2**, and **Setup** are the default key functions which are executed when that key is pressed alone.

To access the function shown in the blue area at the top of a key, press and release the **Shift** key first, then press the desired key. For example, to select the **Speed** function, press and release **Shift**, then press the **Speed** key.





When a number is required, the teach pendant will automatically switch to numeric entry mode. The number represented by each key is shown in the lower right corner of the key.

2.2 Key Assignments

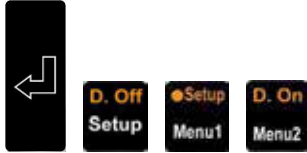

Menu Keys	
	Opens the Point Registration menu.
	Opens the Setup menu.
	Opens Menu # 1.
	Opens Menu # 2.
Jog Keys	
	Jogs the X axis in the left direction.
	Jogs the X axis in the right direction.
	Jogs the Y axis in the backward direction.
	Jogs the Y axis in the forward direction.
	Jogs the Z axis UP.
	Jogs the Z axis DOWN.
	Accelerates jog speed – used with X+, X-. Y+, Y-, Z Up, Z Down

Navigation Display	
	Moves forward (1) memory address.
	Moves backward (1) memory address.
	Moves forward (10) memory addresses.
	Moves backward (10) memory addresses.

2.3 Navigation Menu

<p>Pressing any of the keys shown on the right will open the corresponding menu.</p>	
<p>Once the menu is open, use the up and down arrows to move through the items on the menu.</p>	
<p>Use left and right arrows to change to the next page or previous page of the menu.</p>	
<p>Press ENTER to select the current item.</p>	

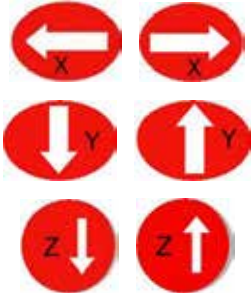
2.4 Jogging

<p>The tip is jogged by pressing the jog buttons</p>	
<p>If the FAST button is pressed and held first, then one of the jog buttons is pressed, the axis will be jogged at the maximum jog speed.</p> <p>If one of the jog buttons is pressed first, then the FAST button is pressed, the jog motion will accelerate.</p> <p>If the FAST button is released, the jog motion will decelerate.</p>	















2.5 Data Entry















If a numeric value is required, the teach pendant will automatically switch to numeric mode. Use the keys 0 – 9, (.) (,) and the minus sign (-) to enter numbers.















2.6 Running a Program



























Press the  key to run the program.

3 Teach Box Key Assignments

Key	Function
	Used to select options shown on the display. The use of this key depends on the current menu displayed.
	Used to select options shown on the display. The use of this key depends on the current menu displayed.
	Used to select options shown on the display. The use of this key depends on the current menu displayed.
	Used to select options shown on the display. The use of this key depends on the current menu displayed.
	Used to select options shown on the display. The use of this key depends on the current menu displayed.
	Rotates 'R' axis clockwise (Four axis robots only)
	Rotates 'R' axis counter-clockwise (Four axis robots only)
	Jogs the Z axis UP.
	Jogs the Z axis DOWN.
	Jogs the Y axis in the forward direction.
	Jogs the Y axis in the backward direction.
	Jogs the X axis in the left direction.
	Jogs the X axis in the right direction.
	Accelerates the jog speed when used with X+, X-, Y+, Y-, Z Up, Z Down.

Key	Function
	If Shift is pressed and released, then another key is pressed, the secondary function of that key (shown in blue) will be executed.
	Inserts a memory address before the current address.
	Deletes the current memory address.
	Clears / erases the numeric value currently shown in the display.
	If pressed once, clears the current numeric value. If pressed twice, cancels the current function. If a program is running, cancels the running program. Changes from Point List display mode to single point display when teaching point data.
	Opens the Point registration menu.
	Changes the display to memory address number 1.
	Moves backward (10) memory addresses.
	Moves backward (1) memory address.
	After opening a menu, use this key to move Up inside the menu.
	Opens Menu # 1.
	Changes the display to the last memory address used in the program.
	Moves forward (10) memory addresses.
	Moves forward (1) memory address.
	After opening a menu, use this key to move Down inside the menu.

Key	Function
	Opens Menu # 2.
	Jumps to a specified memory address
	Moves the tip to the point location currently in the display.
	Registers a XYZ group offset.
	Opens the Setup menu.
	Starts debugging mode.
	Jogs the robot numerically to an absolute position
	Jogs the robot numerically to a position relative to the current location.
	(Enter)—used to confirm data entries. Also opens the Point registration menu.
	Runs the program.
	Homes the robot. Initializes all axes and moves the head to the position (0,0,0).
	Registers a Dispense Dot point.
	Registers a Line Start point.
	Registers a Line Passing point.
	Undo the last change to the program.

Key	Function
 + 	Registers a Line End point.
 + 	Registers an Arc Point.
 + 	Re-Undo the last change which was undone (Redo)
 + 	Registers a Point Dispense Setup command.
 + 	Registers a Line Dispense Setup command.
 + 	Registers a Line Speed command.
 + 	Registers the End Program command.
 + 	Registers a Dispense On point.
 + 	Registers a Dispense Off point.
 + 	Registers a Z Clearance command.
 + 	Registers a Dummy point.
 + 	Registers a Circle point
 + 	Adjusts the tips position after a barrel change

4 Point Type & Function Summary

4.1 Point Menu

Below is a list of Point Types, which are found under the **Enter** key (**Point** menu):

<i>Function</i>	<i>Description</i>
Dispense Dot	Registers the current XYZ location as a Dispense point for dot dispensing.
Line Start	Registers the current XYZ location as a Line Start point for line dispensing.
Line Passing	Registers the current XYZ location as a Line Passing point. This is a location on the line where the tip changes direction, such as at the corner on a rectangle.
Circle	Registers a circle with the circle center at the current XYZ location. The display will prompt the user for the circle diameter.
Arc Point	Registers the current XYZ location as an Arc point. Arc points are used to dispense material in an arc or circle.
Line End	Registers the current XYZ location as a Line End point.
End Program	Registers the current memory address as the end of the program.
Dispense ON / OFF	Registers an instruction which turns the dispenser on or off at the current XYZ location.
Goto Address	Causes the program to jump to the specified memory address.
Step & Repeat X	<p>Registers an instruction that will re-run a selected group of memory addresses, stepping by a user-defined distance in the X or Y axis after each copy. The matrix of parts is defined by specifying the number of rows, the number of columns, the X offset and the Y offset.</p> <p>Step & Repeat X indicates that the robot will give priority to the X axis, running the parts along the X axis first.</p>

<i>Function</i>	<i>Description</i>
Step & Repeat Y	Registers an instruction that will re-run a selected group of memory addresses, stepping by a user-defined distance in the X or Y axis after each copy. The matrix of parts is defined by specifying the number of rows, the number of columns, the X offset and the Y offset. Step & Repeat Y indicates that the robot will give priority to the Y axis, running the parts along the Y axis first.
Brush Area	Causes the tip to 'paint' the defined area. The painted area can be in the form of a rectangle or a circle / spiral.
Call Subroutine	Causes the machine to jump to a specified memory address and execute the instructions found there. When the end program instruction is reached, program execution will continue at address just after the call Subroutine instruction.
Call Program	Jumps to the specified program number from within the current program.
Set I/O	Registers an instruction, which either sets the value of an output signal or checks the status of an input signal.
Wait Point	After executing the current point (Line start, passing, etc) the robot will wait a specified amount of time before moving to the next command.
Stop Point	After executing the current point (Line start, passing, etc), the robot will wait until the start button is pressed before moving to the next command.
Home Point	Registers an instruction to 'home' all axes, sending them to the home position. See the Setup Menu for instructions on changing the location of the home position.
Loop Address	Causes the program to execute a group of memory addresses a user-specified number of times.
Dummy Point	Registers the current XYZ location as a Dummy point. The tip will simply pass through this point. Useful for avoiding obstacles on the work piece.
Initialize	Registers an Initialize point. Causes the robot to perform a mechanical initialization.

<i>Function</i>	<i>Description</i>
Label	Registers a label that can be used as a reference when used with the Goto address, Loop address, Set I/O, Step & repeat X, Step & repeat Y and Call Subroutine commands.
Blend point	Add function after Line Passing when making right angles to slow down the speed on the turning point.

4.2 Setup Menu

Below is a list of functions, which are found under the **Setup** key (**Setup** menu):

<i>Function</i>	<i>Description</i>
Line Speed	Registers the LINE SPEED used for all lines from the current memory address forward until another Line Speed instruction is found.
Line Dispense Setup	Registers the LINE DISPENSE SETUP values which sets dispensing wait time at the start of lines ('head' time), wait time at the passing points ('Node' time) and waiting time at the end of lines ('tail' time). The registered values will be used from the current memory address forward until another Line Dispense Setup instruction is found.
Point Dispense Setup	Registers POINT DISPENSE SETUP values which sets dispensing time and waiting time at the end of dispensing ('tail' time) for dots. The registered values will be used from the current memory address forward until another POINT DISPENSE SETUP instruction is found.
Dispense End Setup	Registers the height and speed the tip should raise at the end of dispensing. The registered values will be used from the current memory address forward until another DISPENSE END SETUP instruction is found.
Z Clearance	Registers the addition distance the tip should rise, beyond the height set in Dispense End Setup, to allow obstacles to be cleared as the tip moves from one figure to another. Values will be used until another Z Clearance instruction is found.
XY Move Speed	Sets the movement speed of the X and Y axes when moving from one figure to another in the program

<i>Function</i>	<i>Description</i>
Z Move Speed	Sets the movement speed of the Z axis when moving from one figure to another in the program
Home Position	Changes the position the robot moves to at the end of a program cycle.
Adjust Position	Registers the current XYZ location as the Adjust Position. This reference point can later be used to correct the program location after the dispensing tip has been changed.
Retract Setup	Registers Retract values at the current XYZ location. Retract causes the tip to move up and back over the dispensed bead after line dispensing.
Quickstep	Causes the robot to move very fast from one point to another reducing the time of the dispensing cycle.
Auto Purge Setup	Automatically purges the system at the end of the program.
ESTOP Output	After receiving the emergency stop signal, ESTOP Output can modify the status of all the outputs or leave them as before receiving the emergency signal.
Acceleration	Parameter that controls the robot's acceleration
Pause Status	Sets the position to which the tip moves after pressing the Start button. The tip can go to the Home position or will stay at the position where the Start button was pressed.
Language	Opens MENU for selecting the language
Tip Detect Position	Vj ku"hwpevkqp"pggf u"vq"dg"qr gtcvgf "y kj "Vkr "J gki j v" F gvgevF gxleg"qr vkqpcn#vq"ugv"wr "vj g"j gki j v'cpf " f gr vj "qh'pggf rg"Vkr "hqt"f gvgevki 0"
Tip Detect Offset	Vj ku"hwpevkqp"pggf u"vq"dg"qr gtcvgf "y kj "Vkr "J gki j v" F gvgevF gxleg"qr vkqpcn#vq"qdvckp"y g"xcnwg"qf'c" pggf rg"r qukvkp0
Running, Home First	In the state of (1) ON, when executing the program, it will first move back to the machine's home point.

<i>Function</i>	<i>Description</i>
Pre-Dispense Wait Time	Preset delay Time before dispensing
Circle Dispense Setup	It will make the finished circle dispensing shutoff for a period of distance while following the circle motion.
Dispense Output	Dispense Output Setup assigns the dispense output port number (0-8) for the line and dot under control of the line dispense setup and point dispense setup.
Tip Search	N/A

4.3 Menu 1

Below is a list of functions, which are found under the **Menu 1** key:

<i>Function</i>	<i>Description</i>
Group Edit	Allows a function to be applied to a user-defined group of memory addresses. Functions include copy, delete, move, multiply line speed, multiply dispense times, apply X Offset, apply Y Offset, apply Z Offset
Expand Step & Repeat	Expands the memory address locations which would be performed at a Step & Repeat instruction so individual memory addresses of the repeated instructions can be edited
Program Name	Allows the user to register a name for the current program number
Z Axis Limit	Sets the MAXIMUM Z axis value (the lowest tip position). Once the Z axis limit is set, the robot will prevent the tip from jogging below the set location.
Initial IO	Sets the status of the output signals when the machine is initialized
Debug Speed	Sets the speed used when running in Debug mode.
Utility Menu	Opens the Utility Menu. See SECTION 3:4.4 Utility Menu
Run Mode	Determines whether the robot operates in Standalone mode (default) or Slave mode. Slave mode allows the robot to be controlled by commands send over the RS232 port.
Resume Program	Determines if a program will restart from point #1 or the point at which it was interrupted if a program is stopped by an emergency stop or the enclosure door switch open signal.
Jog Speed	Allows the user to set the tip jog speed for teach mode: Low, Middle or High jog speed can be selected.
Relocate Data	See “Relocate Data” SECTION 5:3.11 Utility Menu
Move Z Lifting	Allows the user to move through the program from point to point raising or without raising the Z-axis

<i>Function</i>	<i>Description</i>
Z Lifting Length	Sets the Z-height after move Z lifting turn on.

4.4 Utility Menu

Below is a list of functions, which are found under **Menu 1 -> Utility Menu**:

<i>Function</i>	<i>Description</i>
Program	Opens the Program utility menu. Allows programs to be copied, backed up, restored, or cleared.
Memory	Opens the Memory utility menu. Allows the robot memory to be backed up, restored, or cleared.
Teach Pendant	Program can be store in the Teach Pendant or taken out.
Re-rotate Data	Allows the position of a program to be corrected using two reference points. Corrects for X offset, Y offset and angle of rotation.
Lock Program	Locks or unlocks a program to enable or disable program editing
Password Setup	Allows the password to be set or reset for the current program. Protects the program from unauthorized editing.
Cycle Counter	Enables or disables the program cycle counter show in the display when in run mode
Key Beep	Enabling Key Beep will produce a beep every time a key in the Teach Pendant is touched.
Test Function	The Test Function is a diagnostic command used for troubleshooting your robot easily through the robot Teach Pendant.
USB	Allows to: load program from USB, save program to USB, update operating system from USB and backup operating system to USB
Remote Command	It allows the user to call the program number from external device using the RS232 port.
Program Capacity	It allows the user to set to point number in the program. The default value is set to 500 on the robot.
Online Signal	Vj ku"hwpeVkp"ku"q"dg"wugf "ykvj "Y ctpkpi "Hcuj gt"*qr vqpcn0"

<i>Function</i>	<i>Description</i>
Barcode Reader	Function to attach barcode reader to robot.

4.5 Menu 2

Below is a list of functions, which are found under the **Menu 2** key:

<i>Function</i>	<i>Description</i>
Numerical Move	Allows the tip to be positioned numerically by entering a number for the X, Y and Z values.
Save Temp Point	Save Temp Point saves the current XYZ position in a temporary memory area numbered 1 – 9.
Retr. Temp Point	Retrieve Temp Point retrieves a XYZ position which was stored with Save Temp Point.
Undo Program	Cancels the last change to the program. Returns to the program state prior to the last change.
Redo Program	Restores the last change to the program which was canceled with Undo.
Debug Program	Runs the program in Debug mode starting at the current point location.
Home Position	Causes the tip to move to the home position. The default home position is X=0, Y=0, Z=0
System Information	Displays system information, including software version number, work area size and control board version
Execute Point	Runs a selected command.
Cycle time	Displays the total time for executing the program.

SECTION 4: Programming Example

1 Programming Example

To help you become familiar with programming the robot, please follow the instructions below to create a program that dispenses in the following pattern:

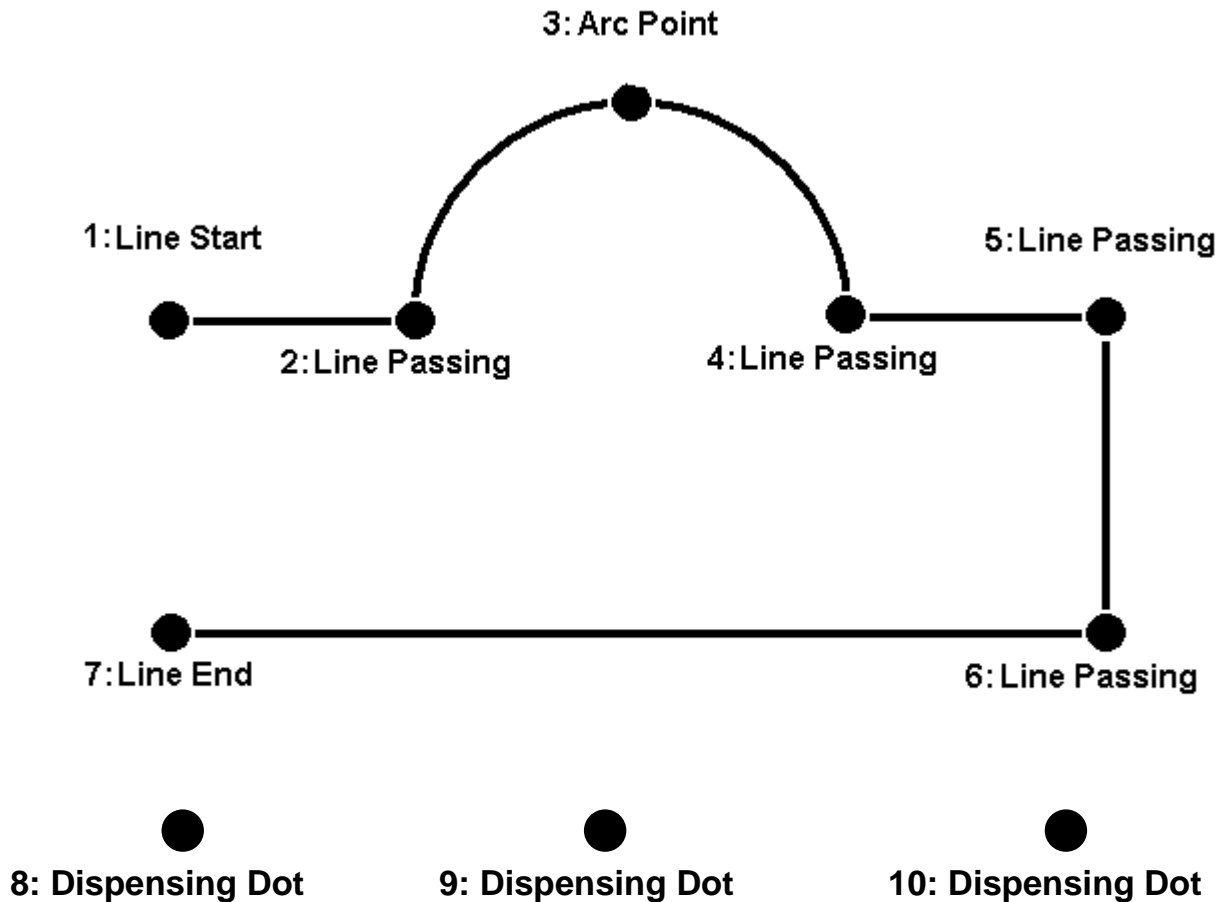

Notes:

- We will create the above program in program # 10.
- We will use a line speed of 40 mm / second for the lines and arcs in the program
- For dots, we will use a dispensing time of 0.50 seconds and a waiting time of 0.1 seconds after dispensing

	<i>Instruction</i>	<i>Display Shows</i>
1	Follow the instructions found in section SECTION 2:3 Setup to setup the robot.	
2	Select program 10 using the program number selection switches on the main unit control panel. Turn the power on.	[MACHINE HOME] +-----+ START/HOME +-----+
3	Press the START button. The robot will move to the home position.	ADDR:1 PROG:10 EMPTY X:0.00 Y:0.00 Z:0.00
4	Press the Setup key, then 1 to select Line Speed to register a line speed of 40 mm/second at memory address number 1.	Line Speed Setup ----- Speed: unit: mm/sec
5	The robot is now waiting for the speed to be registered. Press 40 then ENTER to register a speed of 40 mm / second.	ADDR:2 PROG:10 EMPTY
6	The display shows we are at memory address 2 and that it is empty. Jog the dispense tip to the first location in the diagram above (1: Line Start). To jog the X and Y axes, press the arrow keys (← X , X Ⓜ, - Y , - Y). To jog the Z axis, press the Z- and Z- keys. Press and hold the FAST key to jog fast. See SECTION 3:2.4 Jogging for more information.	
7	Once the tip is at the correct X, Y, Z location for the first point (1: Line Start), press the ENTER/Point key, then 2 to register the location as a Line Start point.	ADDR:3 PROG:10 EMPTY
8	The display will show we are at memory address 3 and it is empty. Jog the tip to the X, Y, Z location of the second point (2: Line Passing). When the location is correct, press the ENTER/Point key, then 3 to register the location as a Line Passing point.	ADDR:4 PROG:10 EMPTY

	<i>Instruction</i>	<i>Display Shows</i>
9	Now jog the tip to the location of the third point (3: Arc Point). When the location is correct, press the ENTER/Point key, then 5 to register the location as an Arc point.	ADDR: 5 PROG: 10 EMPTY
10	Jog the tip to the location of the fourth point (4: Line Passing). When the location is correct, press the ENTER/Point key, then 3 key to register the location as a Line Passing point.	ADDR: 6 PROG: 10 EMPTY
11	Jog the tip to the location of the fifth point (5: Line Passing). When the location is correct, press the ENTER/Point key, then 3 to register the location as a Line Passing point.	ADDR: 7 PROG: 10 EMPTY
12	Jog the tip to the location of the sixth point (6: Line Passing). When the location is correct, press the ENTER/Point key, then 3 to register the location as a Line Passing point.	ADDR: 8 PROG: 10 EMPTY
13	Jog the tip to the location of the seventh point (7: Line End). When the location is correct, press the ENTER/Point key, then 6 to register the location as a Line End point.	ADDR: 9 PROG: 10 EMPTY
14	The line is now complete. The next step is to register the dispense settings for the dots. Press the SETUP key, then 3 to register the dot dispensing time.	Point Dispense Setup ----- Dis. Time: Tail Time: unit: sec
15	Type 0.5 to register a dispensing time of 0.5 seconds, then press ENTER . Type 0.1 to register a waiting time after dispensing of 0.1 seconds, then press ENTER .	ADDR: 10 PROG: 10 EMPTY
16	Jog the tip to the location of first dispense dot (8: Dispense Dot). When the location is correct, press the ENTER/Point key, then 1 to register the location as a Dispense Dot.	ADDR: 11 PROG: 10 EMPTY
17	Jog the tip to the location of second dispense dot (9: Dispense Dot). When the location is correct, press the ENTER/Point key, then 1 to register the location as a Dispense Dot.	ADDR: 12 PROG: 10 EMPTY
18	Jog the tip to the location of third dispense dot (10: Dispense Dot). When the location is correct, press the ENTER/Point key, then 1 to register the location as a Dispense Dot.	ADDR: 13 PROG: 10 EMPTY

	<i>Instruction</i>	<i>Display Shows</i>
19	The program is now complete. Press ENTER/Point , then 7 to register address 13 as the END of the program.	ADDR:14 PROG:10 EMPTY
20	To run the program, press the RUN key..	

2 Good Programming Practices

It is recommended to register the setup commands at the beginning of every program. The following setup commands are the most used:

- Dispense End Setup
- Point Dispense Setup
- Line Dispense Setup
- Line Speed
- Z Clearance
- Retract Setup
- Adjust Position

For a complete list and description of all the different setup commands, refer to *SECTION 3:4.2 Setup Menu* and *SECTION 5:2. Setup Menu*

3 Editing a Program

You can move through the instructions in an existing program by using the following keys:

<i>Key</i>	<i>Function</i>
+1	Moves forward (1) memory address
-1	Moves backward (1) memory address
FIRST	Moves to the first memory address in the program
END	Moves to the last programmed memory address in the program
+10	Jumps forward (10) memory addresses
-10	Jumps backward (10) memory addresses
MOVE	Moves the tip to the XYZ point location of the selected point
JUMP	Jump to display the specified memory address

3.1 Changing a Point's XYZ location

To change the XYZ location of a point, press the **+1** or **-1** key until the point you want to change is shown in the display.

You can confirm that the correct point is in the display by pressing the **MOVE** key. This will cause the tip to move to the XYZ position shown in the display.

Now use the jog keys (← **X**, **X**®, **Y**- , **Y**-) and the **Z**- / **Z**- keys to jog the tip to the new location.

Once the location is correct, simply re-register the point as you did when it was first taught, by pressing the **Point** key and selecting the point type. The point will be re-registered at the new location.

3.2 Insert / Delete an Instruction

- To insert an instruction, press the **INS** key. The point currently shown in the display will be moved forward one memory address. A new, empty memory address will be inserted at the current memory address.
- To delete the instruction currently shown in the display, press the **DEL** key, and then press the key F1(Yes).

4 Changing the Program Number

The program number is selected by the program number selection switches on the main unit's control panel.

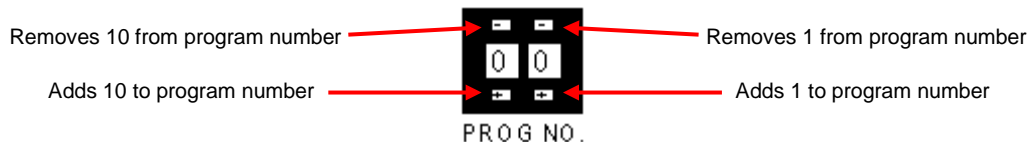

Press the **+** and **-** buttons to select the program number.

5 Changing from Teach Mode to Run Mode

To change from Teach mode to Run mode, change the position of the mode switch on the main unit's control panel.

When the machine is in Run mode, the teaching box is not required. Programs can be selected and run by using the switches on the front control panel of the main unit.

SECTION 5: Point Type & Function Reference

1 Point Menu

Below is a list of functions which are found under the **ENTER/Point** key. These functions are 'point-type' functions, meaning that the values applied will occupy one memory address.

Please see **SECTION 6: Sample Programs** for additional programming examples.

1.1 Dispense Dot

Register the current XYZ location as a dispense point for dot dispensing.

The dispense time and wait time must be set in a previous memory address by registering a **Point Dispense Setup** instruction.

The upward motion of the tip after dispensing can be controlled by registering a **Dispense End Setup** instruction and / or a **Z Clearance** instruction in a previous memory address.

Dispense End Setup and **Z Clearance** instructions are registered using the **SETUP** key.

See also **SECTION 5:2.3 Point Dispense Setup**, **SECTION 5:2.4 Dispense End Setup** and **SECTION 5:2.5 Z Clearance**.

1.2 Line Start

Register the current XYZ location as a Line Start point from **Point menu** for line dispensing.

The line speed must be set in a previous memory address by registering a **Line Speed** instruction using the **SETUP** key.

Dispense delay times used at Line Start and Line End points can be controlled by registering a **Line Dispense Setup** instruction in a previous memory address. The **Line Dispense Setup** instruction is registered by pressing the **SETUP** key.

See also **SECTION 5:2.1 Line Speed** and **SECTION 5:2.2 Line Dispense Setup**.

1.3 Line Passing

Register the current XYZ location as a Line Passing point. This is a location on the line where the tip changes direction, such as at the corner on a rectangle.

Also use a Line passing point before and after an Arc Point instruction.

1.4 Circle

Dispensing a circle using the circle command has 2 options; radius or three points.

Circle Radius:

Registers a circle, where the circle's center is at the current XYZ location. To register a circle, jog the tip to the circle's center and press **POINT MENU**, and then press the key 4 (for circle). The display will prompt you to type the following data:

Radius: Type the Radius of the circle and press **ENTER**.

Over Angle: (The value is from 1~360). After dispensing the circle, while going through an extra part of the circle defined by the Over Angle, the dispenser will be turned OFF.

Z Lift: 1. Yes 2. No

Selection: If you want the Z-axis (tip) to lift while going through the Over Angle, you must select 1. Otherwise: select 2.

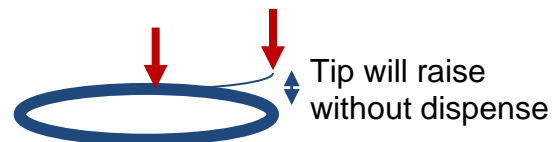
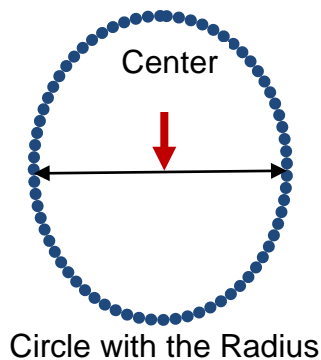

Z Lift is ON 90 Degree

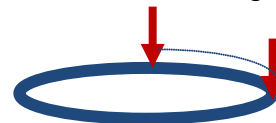

Z Lift is OFF 90 Degree

Circle Three Points:

Registers a Circle, selecting the three XYZ Points on the circle will create a Circle dispense.

[F2]: Three points

Over Angle: (The value is from 1~360). After dispensing the circle, while going through an extra part of the circle defined by the Over Angle, the dispenser will be turned OFF.

Z Lift: 1. Yes 2. No

Selection: If you want the Z-axis (tip) to lift while going through the Over Angle, you must select 1. Otherwise: select 2.

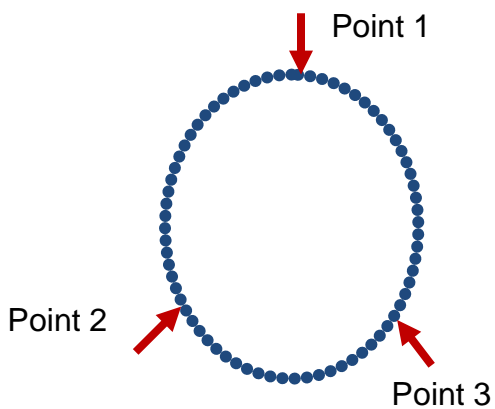

Circle with the Three Points

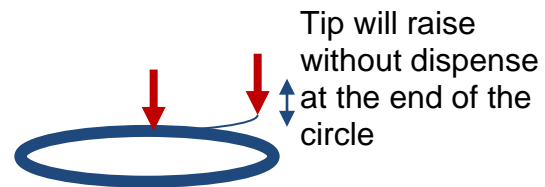

Z Lift is ON 90 Degree

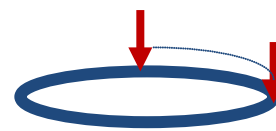

Z Lift is OFF 90 Degree

The speed must be set in a previous memory address by registering a **Line Speed** instruction using the **SETUP** key.

Dispense delay times used at the start of the circle and the end of the circle can be controlled by registering a **Line Dispense Setup** instruction in a previous memory address. The **Line Dispense Setup** instruction is registered by pressing the **SETUP** key.

See also **SECTION 5:2.1 Line Speed** and **SECTION 5:2.2 Line Dispense Setup**.

The upward motion of the tip after dispensing can be controlled by registering a **Dispense End Setup** instruction and / or a **Z Clearance** instruction in a previous memory address.

Dispense End Setup and **Z Clearance** instructions are registered using the **SETUP** key.

See also SECTION 5: **SECTION 5:2.4 Dispense End Setup** and **SECTION 5:2.5 Z Clearance**.

1.5 Arc Point

Register the current XYZ location as an Arc Point. Arc points are used to dispense material along an arc or circular path.

See SECTION 4: *Programming Example*, for an example of the use of an Arc Point.

1.6 Line End

Register the current XYZ location as a Line End point.

The dispense delay time used at the end of the line can be controlled by registering a *Line Dispense Setup* instruction in a previous memory address. The *Line Dispense Setup* instruction is registered by pressing the **SETUP** key.

See also *SECTION 5:2.2 Line Dispense Setup*.

The upward motion of the tip after dispensing can be controlled by registering a **Dispense End Setup** instruction and / or a **Z Clearance** instruction in a previous memory address.

Dispense End Setup and *Z Clearance* instructions are registered using the **SETUP** key.

1.7 End Program

Register the current memory address as the end of the program. The end program instruction will cause the tip to return to the home position at the end of the program cycle.

1.8 Dispense ON / OFF

The Dispense ON / OFF instruction will allow the user to program an instruction which will turn the dispenser ON or OFF.

This is useful for turning the dispenser OFF before the end of a line to prevent excess material at the line end.

Problem: Too much material at the end of the line



Solution: Turn the dispenser OFF before the end of the line

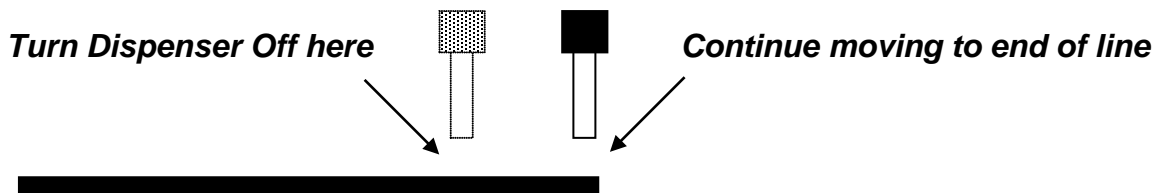

To register a DISPENSE OFF instruction, jog the tip to the XYZ location where you want the dispenser OFF, enter that location as a Line Passing point, then press the **ENTER** key and select **Dispense ON / OFF**.

Press **1** to select Dispense ON or press **2** to select Dispense OFF.

1.9 Goto Address

Make the program to jump to the specified memory address.

1.10 Step & Repeat X

Step & Repeat X allows a group of instructions to be run repeatedly, stepping a given distance in the X axis or Y axis between each cycle.

Step & Repeat X is useful when a fixture is mounted on the robot which holds many identical work pieces aligned in rows and columns. The user needs only to create a program for the first work piece in the fixture, and then use the Step & Repeat function to dispense to the other work pieces.

The Step& Repeat function will allow the user to define the number of rows, the number of columns, the X Offset between each part, and the Y Offset between each part.

If, for example, we have a program which dispenses four dots of material on a work piece:

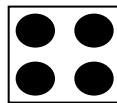

The program would consist of the following eight instructions:

Address	Instruction
1	Dispense End Setup: H.Speed = 100 mm/s, L.Speed = 15 mm/s, L.Length = 5mm
2	Z Clearance: Relative 10 mm
3	Point Dispense Setup: Dis.Time = 0.25 s Tail Time = 0.10 s
4	Dispense Point
5	Dispense Point
6	Dispense Point
7	Dispense Point
8	End Program

If a fixture is made which holds (12) work pieces, in four columns by three rows:

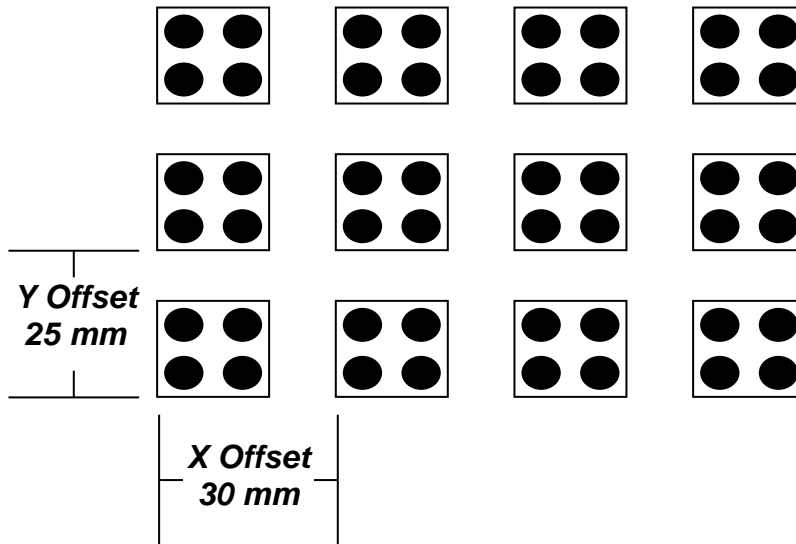

A Step & Repeat X instruction can be used to repeat the program at the additional (11) locations.

The instruction at memory address 8 should be changed from End Program to Step & Repeat X. To register a Step & Repeat X instruction at memory address 8, do the following:

	<i>Instruction</i>	<i>Display Shows</i>
1	Press the +1 or -1 keys until memory address 8 is shown in the display	ADDR: 8 PROG: 20 End Program
2	Press the Point key, and then press the X® key to change to page 2. Select Step & Repeat X , by pressing the 3 key	Step & Repeat X Columns (X) : Rows (Y) :
3	Type 4 to specify four columns, then press ENTER .	Step & Repeat X Columns (X) : 4 Rows (Y) :
4	Type 3 to specify three rows, then press ENTER .	Step & Repeat X Columns (X) : 4 Rows (Y) : 3

	<i>Instruction</i>	<i>Display Shows</i>
5	In the above example, the X Offset between parts is 30 mm. Type 30 to specify an X Offset of 30 mm, then press ENTER .	Step & Repeat X X Offset:30 Y Offset: Unit: mm
6	In the above example, the Y Offset between parts is 25 mm. Type 25 to specify 25 mm, then press ENTER .	Step & Repeat X X Offset:30 Y Offset:25 Unit: mm
7	The display will prompt you to select <i>1. S Path</i> or <i>2. N. Path</i> . Selecting <i>S PATH</i> will cause row 1 columns 1 to 4 to be dispensed, then row 2 column 4 to 1, then row 3 column 1 to 4. Selecting <i>N PATH</i> will cause row 1 columns 1 to 4 to be dispensed, then row 2 columns 1 to 4, then row 3 columns 1 to 4. Press 1 to select S PATH , then press ENTER	Step & Repeat X 1. S Path 2. N Path Select:1
8	The display will prompt you for the <i>Start Address</i> : The start address is the memory address of the first instruction which is part of this Step & Repeat group. In our example, we want to repeat all instructions starting with memory address number 4. Type 4 to specify memory address 4, then press ENTER .	Step and Repeat X Address:4 [F1]Address [F2]Label
9	The program is now complete. Press Point , then select End Program to mark address 9 as the new End Program instruction. Press the 7 key then press ENTER . Press RUN to run the program.	ADDR:9 PROG20 End Program

The program will run in the following pattern and consists of the following instructions:

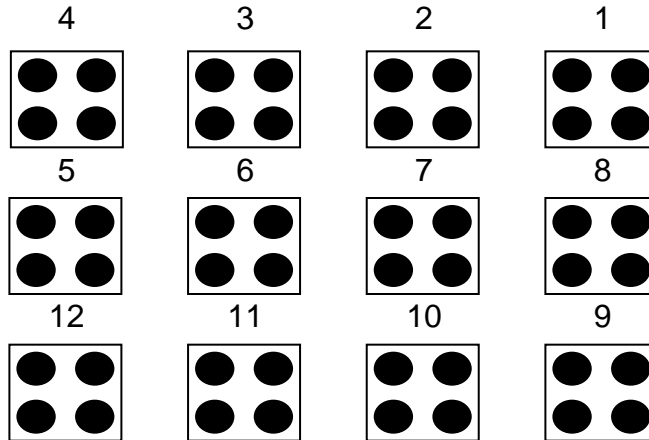

Address	Instruction
1	Dispense End Setup: H.Speed = 100 mm/s, L.Speed = 15 mm/s, L.Length = 5mm
2	Z Clearance: Relative 10 mm
3	Point Dispense Setup: Dis.Time = 0.25 s Tail Time = 0.10 s
4	Dispense Point
5	Dispense Point
6	Dispense Point
7	Dispense Point
8	Step & Repeat X: Cols: 4, Rows: 3, X Off: 30mm, Y Off: 25mm, Addr 4, S Path
9	End Program

The previous example was done using S Path. The difference between S Path and N Path is the order in which the pieces are run:

Step & Repeat X:

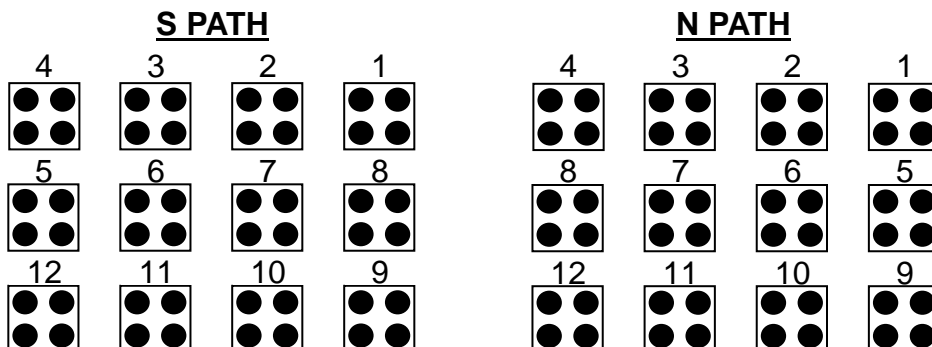

1.11 Step & Repeat Y

Step & Repeat Y works just as Step & Repeat X does, with one difference: priority is given to the Y axis instead of the X axis.

Step & Repeat X - S PATH

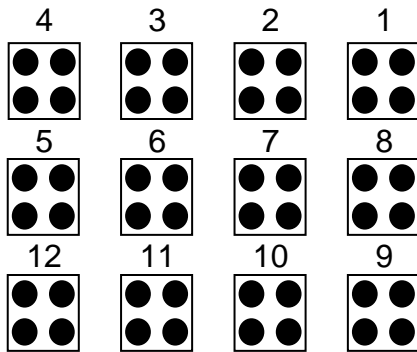

Step & Repeat Y - S PATH

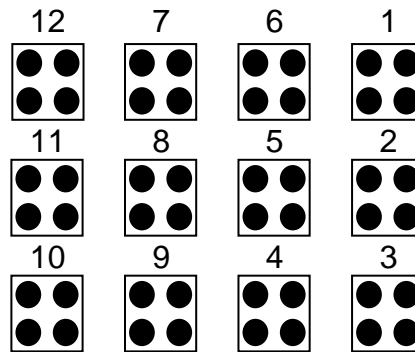

1.12 Brush Area

The Brush Area command causes the tip to 'paint' a defined area.

There are five Brush Area types: Rectangle, Rectangle 1, Rectangle band, Circle and Circle Band. The next pages provide a detailed description of all the Brush area types.

To register a *Brush Area* command, follow the instructions below.

	<i>Instruction</i>	<i>Display Shows</i>
1	Press ENTER to open the Point Menu	[POINT] 1/4 1 Dispense Dot 2.Line Start . . 7 End Program
2	Press Xà , to go to page 2	[POINT] 2/4 . . 5 Brush Area 6 Call Subroutine 7 Call Program
3	Press 5 to select Brush Area.	Brush Area Setup ----- 1.Rectangle 4.Rect Band 2.Circle 5.Circle Band 3.Rectangle 1 Select:
4	Press the numeric key corresponding to the brush area type then press ENTER	Brush Area Setup ----- 1.Rectangle 4.Rect Band 2.Circle 5.Circle Band 3.Rectangle 1 Width(mm) : Band(mm) :
5	Type the width value and press ENTER . Type the band value and press ENTER . Width and band values will be explained further in this section.	

1.12.1 Brush Area: Rectangle

Brush Area rectangle causes the tip to 'paint' the defined area by passing back and forth along the X axis, while moving the Y axis a determined *Brush Width* distance after each pass along the X axis.

After registering the Brush Area Rectangle command, teach a Line Start point at the top left corner of the area to be brushed and a Line End point at the bottom right corner of that area (the tip will not dispense a straight line between these two points):

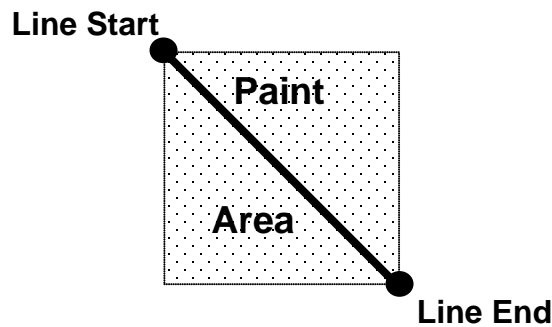

If, for example, a brush width of 5 mm was used, the tip will take the following path when the program is run:

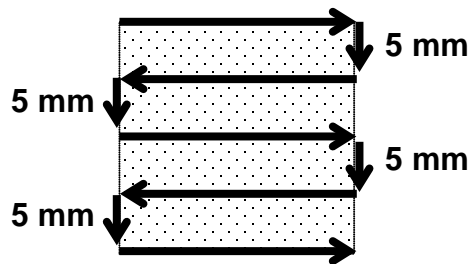

1.12.2 Brush Area: Circle

Brush Area circle causes the tip to 'paint' the defined area by following a spiral path from the outside of the circle to the center.

After registering the Brush Area Circle command, jog the tip to a point on the outside limit of the circle to be brushed and register that location as a Line Start point. Then jog the tip directly across to the center of the circle and register that location as a Line End point (the tip will not dispense a straight line between these two points):

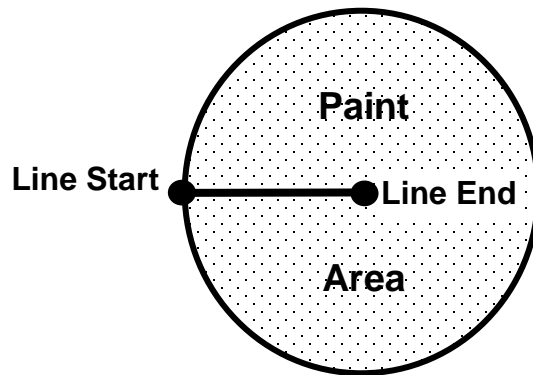

If, for example, a brush width of 5 mm was used, the tip will take the following path when the program is run:

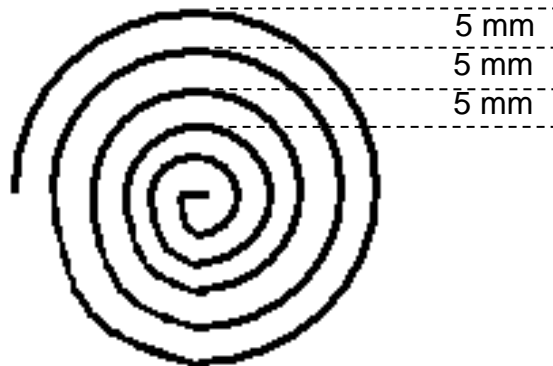

1.12.3 Brush Area: Rectangle 1

Brush Area rectangle 1 causes the tip to 'paint' the defined area by following a square spiral path from the outside of the rectangle to the center.

After registering the Brush Area Rectangle 1 command, teach a Line Start point at the top left corner of the area to be brushed and a Line End point at the bottom right corner of that area (the tip will not dispense a straight line between these two points):

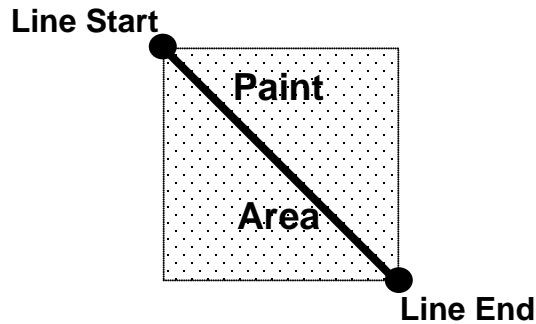

If, for example, a brush width of 5 mm was used, the tip will take the following path when the program is run:

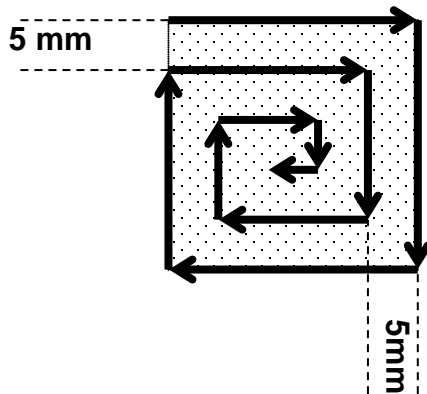

1.12.4 Brush Area: Rect Band

Brush Area Rect Band causes the tip to 'paint' a defined rectangular band area by following a square spiral path from the outside of the rectangle to the center.

After registering the Brush Area Rect Band command, teach a Line Start point at the top left corner of the area to be brushed and a Line End point at the bottom right corner of that area (the tip will not dispense a straight line between these two points):

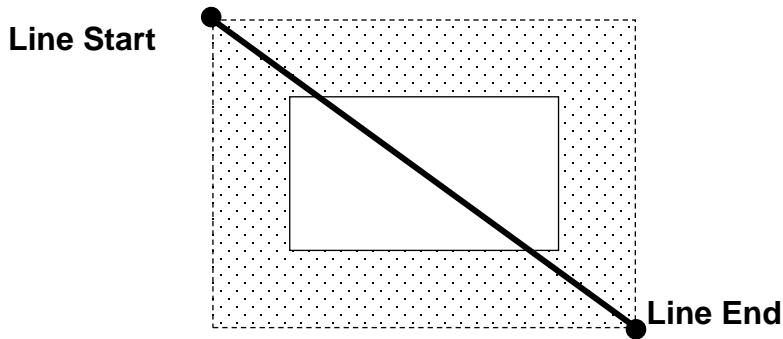

If, for example, a brush width of 5 mm and band of 15mm was used, the tip will take the following path when the program is run:

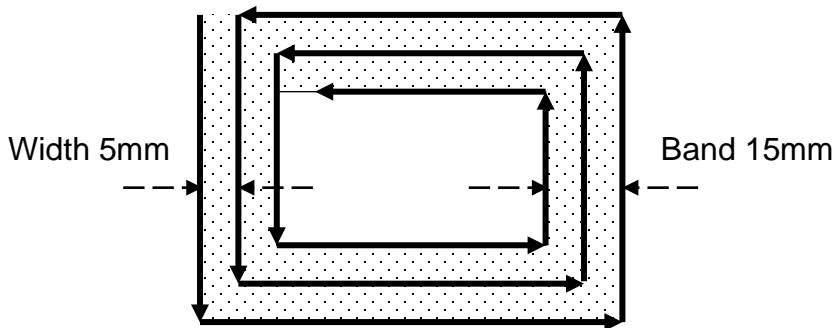

1.12.5 Brush Area: Circle Band

Brush Area Circle Band causes the tip to 'paint' a defined circular band area by following a spiral path from the outside of the circle to the center.

After registering the Brush Area Circle Band command, jog the tip to a point on the outside limit of the circle to be brushed and register that location as a Line Start point. Then jog the tip directly across to the center of the circle and register that location as a Line End point (the tip will not dispense a straight line between these two points):

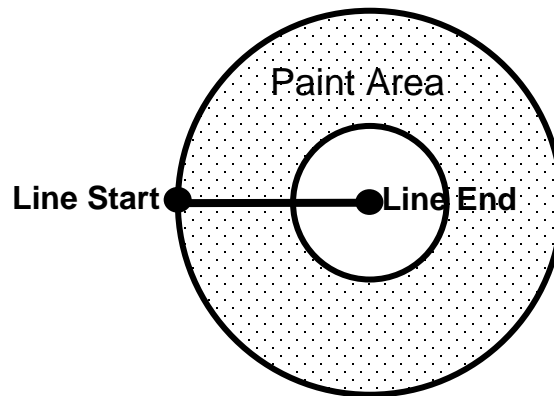

If, for example, a brush width of 5 mm and band of 15mm was used, the tip will take the following path when the program is run:

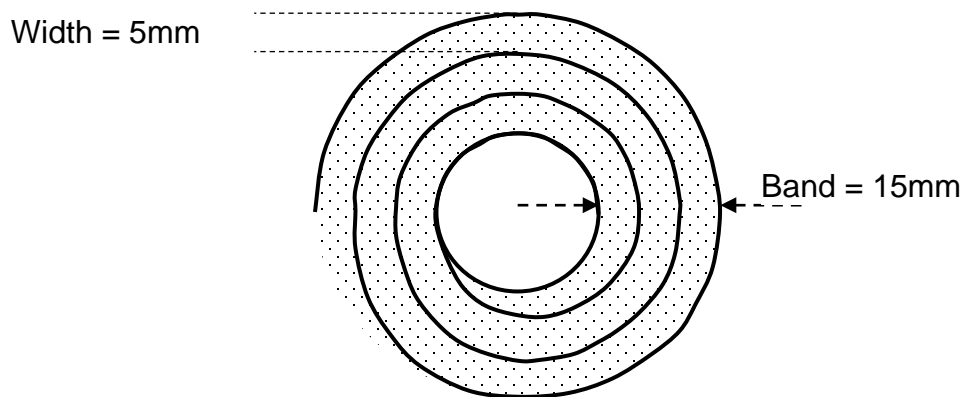

1.13 Call Subroutine

A subroutine is a set of instructions that are located after the End Program instruction. **Call Subroutine** causes the machine to jump to a specified memory address and execute the instructions found there using coordinates specified at the **Call Subroutine** instruction. When the *End Program* instruction for the subroutine is reached, program execution will continue at the address immediately after the **Call Subroutine** instruction. The **Call Subroutine** function is most useful to repeat a pattern anywhere on the work-piece, as opposed to the *Step & Repeat* function where the pattern must be repeated in straight lines, at fixed distances from each other.

The following example illustrates the use of the *Call Subroutine* instruction. An explanation follows.

Address	Instruction
1	Line Speed = 20
2	Call Subroutine (X1,Y1,Z1) address 7
3	Call Subroutine (X2,Y2,Z2) address 7
4	Call Subroutine (X3,Y3,Z3) address 7
5	Call Subroutine (X4,Y4,Z4) address 7
6	End Program
7	Line Start (Xs,Ys,Zs)
8	Line End (Xe,Ye,Ze)
9	End Program

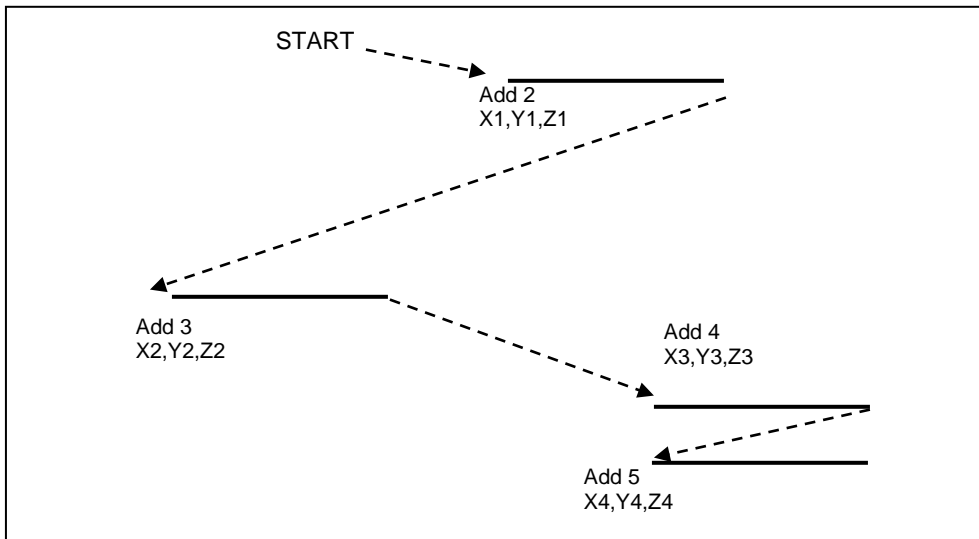

Address 7 and 8 comprise the subroutine that will be executed whenever it is called within the main program. The coordinates in the body of the subroutine (Xs,Ys,Zs,Xe,Ye,Ze) are not important; *the critical information is the relative position to each other*. The actual work will be performed on the coordinates in the main body of the program. Before using the **Call Subroutine** instruction, the tip must be jogged to the first point where the user wants the work to occur. This point must correspond to the *relative* first point defined in the subroutine.

1.14 Call Program

Call Program will jump to the specified program number and execute the program data in the destination program until the End Program command is reached. When the destination program is executed, the robot will return to the calling program.

1.15 Set I/O

Set I/O registers an instruction, which either sets the value of an output signal or checks the status of an input signal.

When the Set I/O function is registered, the user is prompted to select *1. Input* or *2. Output*.

If **1. Input** is selected; the user can enter the **input Port** (input # 1 – 8), the input **Status** (1/0) and the address to **Goto** if that input status occurs. The input status is (0) when the input pin is connected to ground. The input status is (1) if the input pin is disconnected.

If **2. Output** is selected, the user can enter the output **Port** (output # 0 – 8), and whether the output should be turned **ON** or **OFF**.

Please see **SECTION 6: Sample Programs** for an example of the *Set I/O* instruction.

1.16 Wait Point

Register a Wait Point at the current X, Y, Z location. When executed, the tip will move to that location and wait for the specified period of time.

1.17 Stop Point

Register a Stop Point at the current X, Y, Z location. When executed, the tip will move to that location and wait until the start button is pressed.

1.18 Home Point

Register an instruction to 'home' all axes, sending them to the home position. It works like a "Move" command.

It works like an "End Program" function when registered at the end of the program. After program completion, the dispensing tip moves to the home position. If used in the body of the program, the tip is moved to the home position and the next instruction is executed.

This function uses the *Home Position* coordinates (under Setup menu) if a new Home Position is made. Otherwise, it uses the default home position (X=0, Y=0, Z=0). See the Setup Menu for instructions on changing the location of the home position.

1.19 Loop Address

Register an instruction which will execute a group of instructions a user-specified number of times.

When the **Loop Address** instruction is registered, the display will prompt for an **Address** and **Count**.

Address is the memory address to jump to from the current address. This address must be less than the current memory address.

Count is the number of times to execute the loop.

1.20 Dummy Point

Register the current XYZ location as a Dummy point. The tip will simply pass through this point. A dummy point is useful for avoiding obstacles on the work piece.

1.21 Initialize

Register an Initialize point. Cause the robot to perform a mechanical initialization. The tip will home to position (0,0,0,0) and the robot will re-find the home position using the home position sensors.

1.22 Label

Register a label that can be used as a reference when used with the Goto, Loop address, Set I/O, Step & repeat X, Step & repeat Y and Call Subroutine commands.

Label can be used instead of Address number. A maximum of 64 labels is permitted per program; each label can have up to 8 characters.

1.23 Blend Point

Execute on the cartesian point of line dispensing. Line speed may be too fast to dispense on the right angle and becoming an arc. In order to do so by adding Blend Point, it will slow down the speed before going to the right angle, and dispense a perfect motion of cartesian point.

Method: Add function Blend Point after Line Passing command at same location to slow down the speed on the turning point.

C f t g u u "	E q o o c p f "
3 "	N p g " u r g g f " 4 2 2 "
4 "	N p g " u c t v "
5 "	N p g " r c u k p i "
6 "	D r g p f " r q k p v "
7 "	N p g " r c u k p i "
8 "	D r g p f " r q k p v "
9 "	N p g " r c u k p i "
: "	N p g " g p f "
; "	G p f " r t q i t c o "

2 Setup Menu

Below is a list of functions which are found under the **SETUP** key. These functions are all related to the setup of dispensing parameters.

2.1 Line Speed

There are two options available. [F1] Line Speed (mm/sec) and [F2] Travel Time (sec)

1. Line Speed: Registers the line speed used for all lines from the current memory address forward until another Line Speed instruction is found.
2. Travel Time: Will automatically set robot speed to complete the line dispense path in the preset time. Time will start at Line Start command and stop at Line End command in the program. Every Line command in between will be affected.

Warning: Do not set the Travel Time too low or risk damage to the robot axis due to excessive speeds.

2.2 Line Dispense Setup

When dispensing high viscosity materials, there is often a delay from the moment the dispenser is turned on until the material begins to flow. The following parameters are set under this function: Head Time, Tail Time, Node Time and Tail Length.

The **Head Time** setting is a delay time used at the start of line dispensing to prevent the tip from moving along the line path until the material is flowing.

The tip will move to the start of the line, turn on the dispenser and wait for the time period specified in the *head time* setting before moving. The time value can be adjusted to ensure that the material begins flowing at the same time as the line movement begins.

At the end of dispensing, a delay is often required after the dispenser is turned off, to allow the barrel pressure to equalize, before moving to the next point location. This prevents material from being 'spilled' where it is not wanted. This time delay at the end of dispensing is called the **Tail Time**.

The **Node Time** parameter enters a wait time that only affects the **Line Passing** command. Tip will pass through line passing point and will **wait at line passing point** with the dispenser **activated** for the time specified in the **Node Time**.

Usually the material continues flowing after the dispenser is off, due to pressure built in the system. **Tail Length** automatically turn off the dispenser at a user defined distance before the end of a line, preventing excess of material to be deposited at the end of the line.

The value will be used for all lines from the current memory address forward until another **Tail Length** instruction is found.

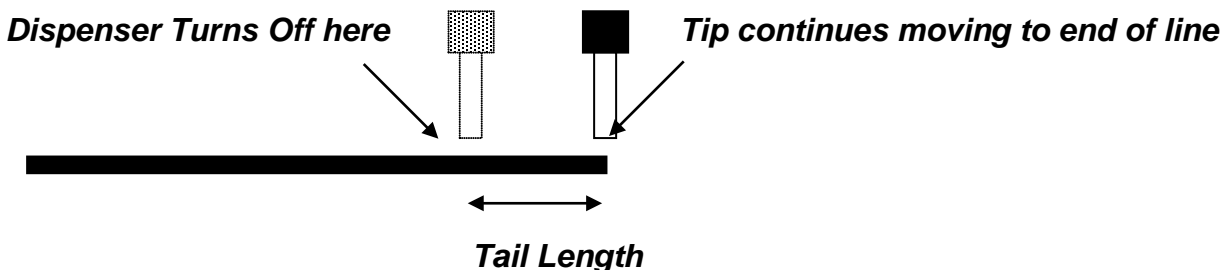

Values for the *Head Time* and *Tail Time* used when performing line dispensing are registered by pressing the **SETUP** key, then selecting **Line Dispense Setup**. The set values will be used by all lines from that memory address forward until new set of *Line Dispense Setup* values are found.

Please see **SECTION 6: Sample Programs** for an example of the *Line Dispense Setup* instruction.

2.3 Point Dispense Setup

Registers POINT DISPENSE SETUP values which set dispensing time and waiting time at the end of dispensing ('tail' time) for dots. The registered values will be used from the current memory address forward until another POINT DISPENSE SETUP instruction is found.

2.4 Dispense End Setup

Dispense End Setup allows the **L.Length**, **L. Speed** and **H. Speed** values to be registered at a memory address. These values will affect how far and how fast the tip rises after dispensing.

After dispensing a dot or line, it is often required to raise the tip a short distance at a slow speed. This allows the material to cleanly break free from the tip, without 'dragging' material where it is not wanted.

The distance and speed that the tip raises after dispensing is controlled by the **L.Length** and **L.Speed** settings.

After the tip raises the length specified by **L.Length** at the speed specified by **L.Speed**, the tip will continue rising to the **Z Clearance** height at the speed specified by **H.Speed**. The purpose of specifying a Z Clearance height is to allow the tip to raise high enough to clear any obstacles it may encounter on the way to the next point.

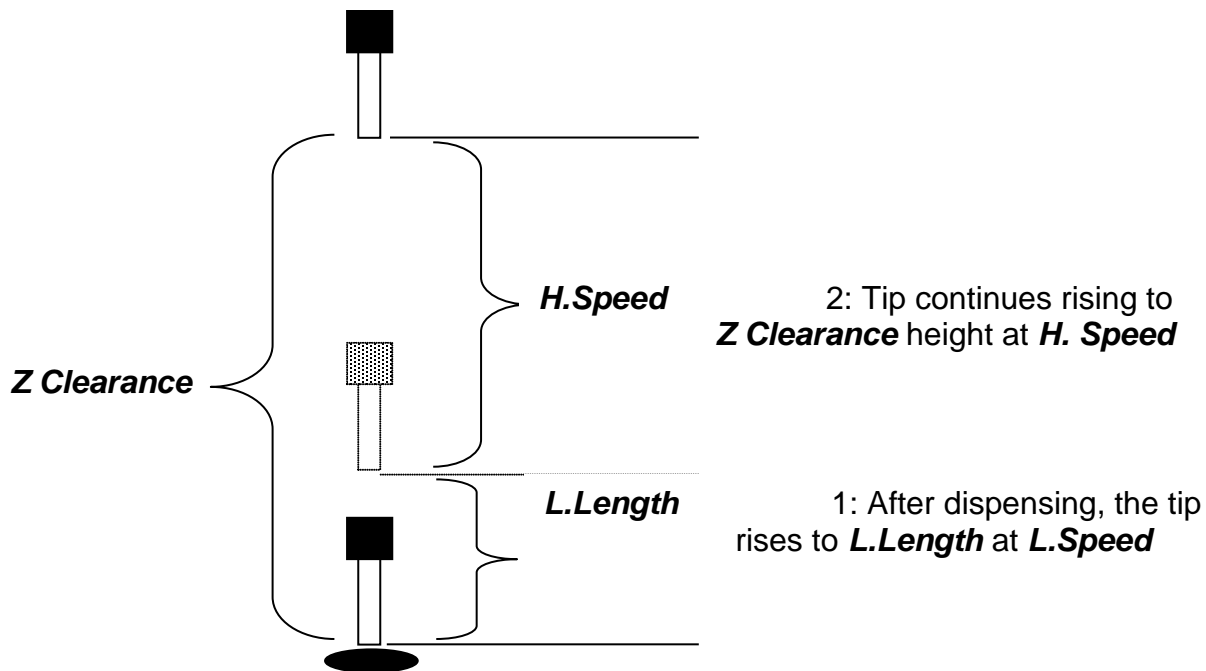

Values for **H.Speed**, **L.Speed** and **L.Length** are registered with the *Dispense End Setup* function by pressing the **SETUP** key, then choosing **Dispense End Setup**.

Once *Dispense End Setup* values have been registered at a memory address, all points after that memory address will use the values specified. If *Dispense End Setup* values are

registered again, at a higher memory address, all of the points from that memory address forward will use the new values.

Please see **SECTION 6: Sample Programs** for an example of the *Dispense End Setup* instruction.

2.5 Z Clearance

The purpose of the Z Clearance function is to cause the tip to raise high enough to clear all obstacles as it moves from one point to another. If there are no obstacles between any of the program points, a small Z Clearance value, such as 5 mm, can be used to minimize the program cycle time.

Values for the *Z Clearance* are registered by pressing the **SETUP** key, then choosing **Z Clearance**. The *Z Clearance* value will be used by all points from that memory address forward until another *Z Clearance* value is found. Normally, a Z clearance instruction should be registered in the beginning of a program, at one of the first memory addresses.

The Z Clearance value may be specified as a relative value or an absolute value. When specified as a relative value, it is the distance to rise relative to the taught point location. When it is specified as an absolute value, it is a distance from the Z axis zero position which the tip will rise to, regardless of the Z axis value of the taught point location. For example:

Z Clearance = 10 mm RELATIVE:

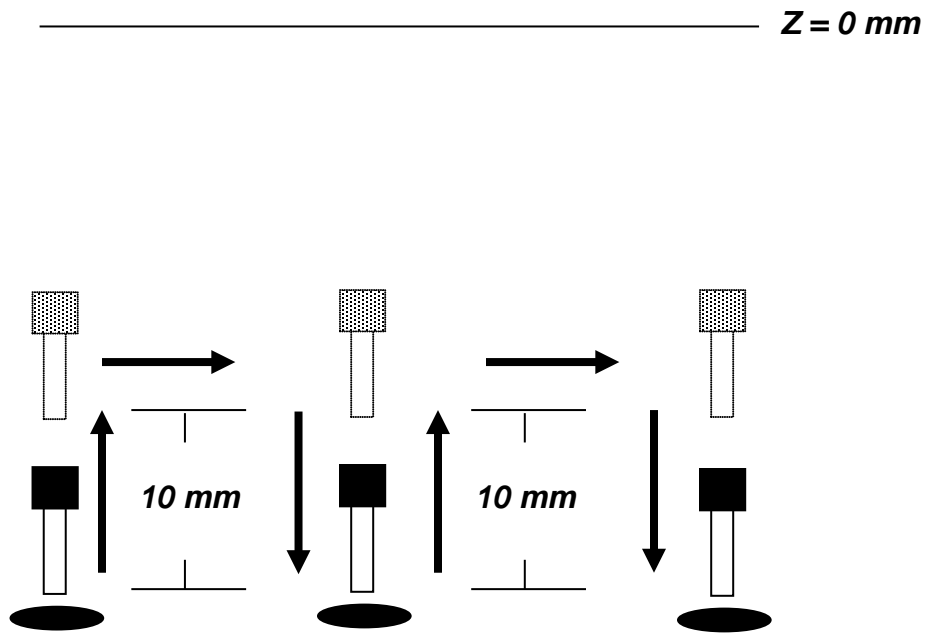

Please see **SECTION 6: Sample Programs** for an example of the *Z Clearance* instruction.

Z Clearance = 10 mm ABSOLUTE:

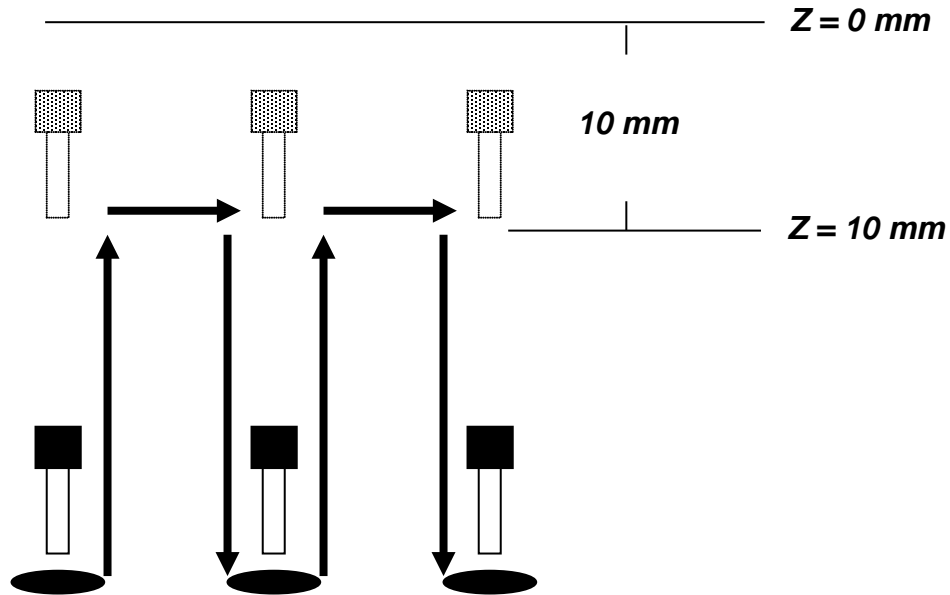

2.6 X/Y Move Speed

X/Y Move Speed sets default X and Y axis movement speed as the tip moves between figures in a program, such as from one dispense point to another or from the end of line dispensing to the next start of line dispensing.

2.7 Z Move Speed

Z Move Speed sets default Z axis movement speed as the tip moves between figures in a program, such as from one dispense point to another or from the end of line dispensing to the next start of line dispensing.

2.8 Home Position

Home Position allows the user to change the location of the program home position. The home position is the location where the tip will move to at the end of a program cycle if the “End Program” or “Home Point” instruction is registered. The default *Home Position* is ($X=0$, $Y=0$, $Z=0$).

To change the home position, jog the tip to the desired location for the new home position, then press **Setup** ® **Home Position**.

NOTE: When executing a program in TEACH MODE, the robot will move to the mechanical home position ($X=0$, $Y=0$, $Z=0$) at the start of every program cycle. When executing a program in RUN MODE, the robot will move to the home position set under the Setup ® Home Position.

2.9 Adjust Position

When the dispensing barrel or tip is removed and replaced, the new tip is often in a slightly different XYZ position than the old tip was. The F4200N series robot has a software utility to adjust a program's origin, thereby correcting the tip's offset problem.

A reference point should be chosen someplace on the work piece fixture or on the work piece itself. The reference point must be registered in the program data. This only needs to be done one time, such as when the program is originally created.

	<i>Instruction</i>	<i>Display Shows</i>
1	Jog the tip to the reference point (i.e. X=10, Y=20, Z=30) Or if the reference point is an existing point in your program, press the MOVE key to bring the tip to that XYZ location.	
2	Press the SETUP key, and go to page two	[SETUP] 2/3 1 Home Position 2 Adjust Position . . 7 Acceleration
	Press 2 to Select Adjust Position . The current point will be saved automatically.	Set Adjust Position ----- X:10 Y:20 Z:30

When the tip/barrel is changed, use the following procedure to adjust the program's origin for the new tip location:

	<i>Instruction</i>	<i>Display Shows</i>
	Switch the robot to RUN mode (the main unit mode switch is in the RUN position)	Counter:0 +-----+ START/HOME +-----+
1	Press the F1 key.	[Run Menu] 1/1 1. Reset Counter 2. Adjust Origin 3. Relocate Data 4. Tip Z Detect

	<i>Instruction</i>	<i>Display Shows</i>
2	Press 2 to select <i>Adjust Origin</i> .	<pre>[MESSAGE BOX] ----- Press [ENTER] Adjust Position -----</pre>
3	<p>Press the Enter key. The tip will move to the reference point previously saved (x=10, y=20, Z=30).</p> <p>If the new tip's location is slightly difference than the last tip's location, you should see that the tip is not exactly at the reference point</p>	<pre>[MESSAGE BOX] ----- Move TIP ----- X10 Y20 Z30</pre>
4	<p>Jog the tip to the correct location for the reference point.</p> <p>When the location is correct, press ENTER. The program origin will be adjusted for the new tip location.</p>	<pre>[MACHINE HOME] +-----+ START/HOME +-----+</pre>

2.10 Retract Setup

The *Retract* function gives the programmer a high level of tip control at the end of line dispensing. It allows the tip to reverse direction, back along the dispense path, and up after line dispensing or move forward, at an angle. This is useful when dispensing high viscosity or 'stringy' materials as it will lay the material's tail down on the dispensed bead.

There are five types of the Retract Setup functions: 0 (Normal), 1(Back), 2(Square Back), 3(Forward) and 4(Square Forward).

#0: RETRACT (NORMAL)

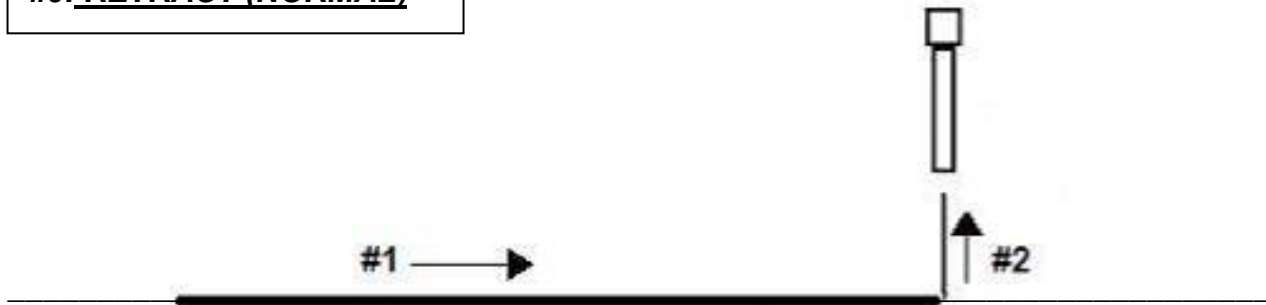

#1: RETRACT (BACK)

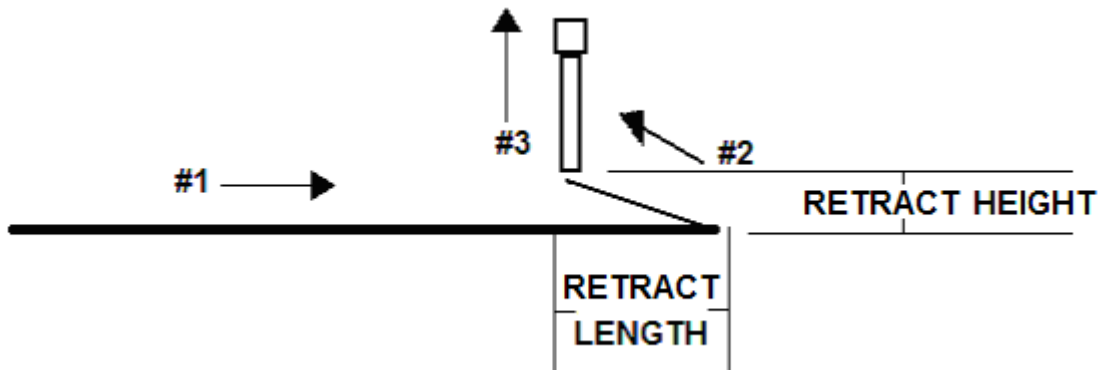

#2: RETRACT (SQUARE BACK)

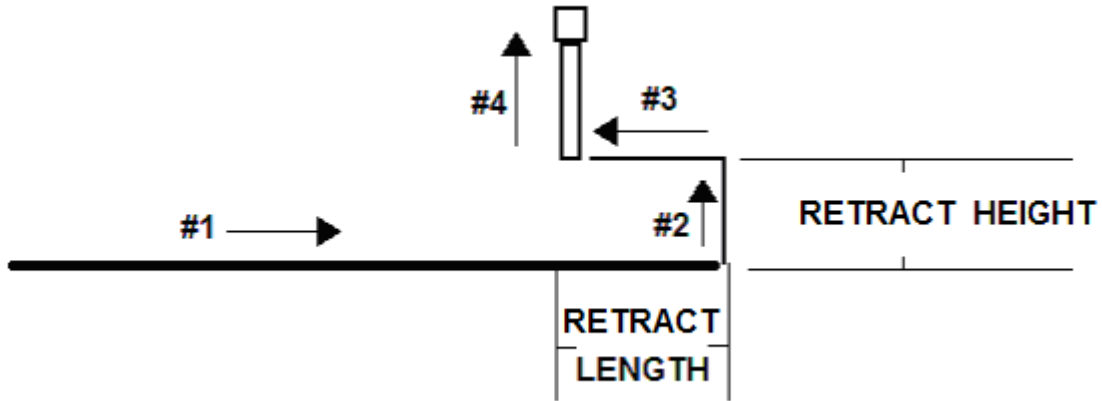

#3: RETRACT (FORWARD)

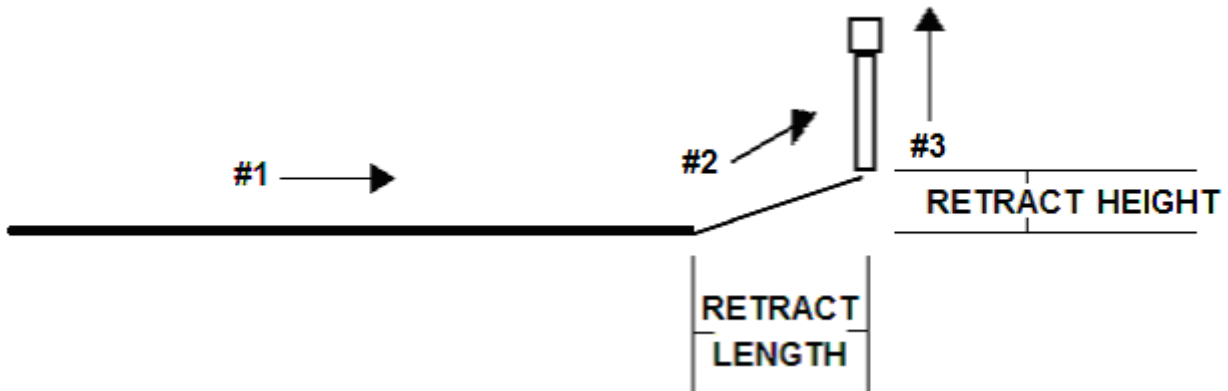

#4: RETRACT (SQUARE FORWARD)

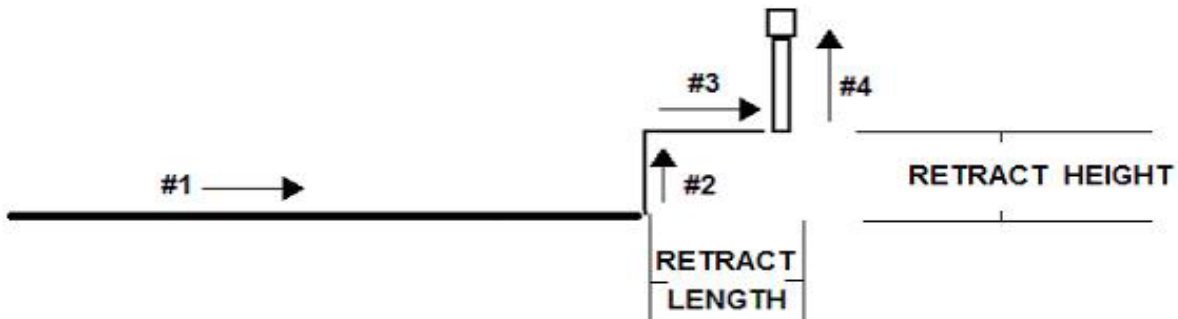

The retract function requires the following parameters:

- RETRACT LENGTH:** the distance to travel away from the line end point
RETRACT HEIGHT: the distance to rise as the tip moves away from the line end. This must be smaller than the value of Z-clearance in that point.
RETRACT SPEED: the speed at which to move along the retract path

- RETRACT TYPE:**
0. NORMAL
 1. BACK
 2. SQUARE BACK
 3. FORWARD
 4. SQUARE FORWARD

Retract values will be used for all lines from the current memory address forward until another Retract instruction is found or the function is canceled.

2.11 Quickstep

Cause the robot to move very fast from one point to another reducing the time of the dispensing cycle.

2.12 Auto Purge Setup

After the end of a program, the tip will go to the home position and material will be purged in a continuous loop according to the parameters registered in the Auto Purge Setup command. This command is very useful for two part materials that have a very short pot life. For example, if a Wait Time of 5s and a Purge Time of 2s is registered in the Auto Purge Setup, the following chart shows the Purge pattern.

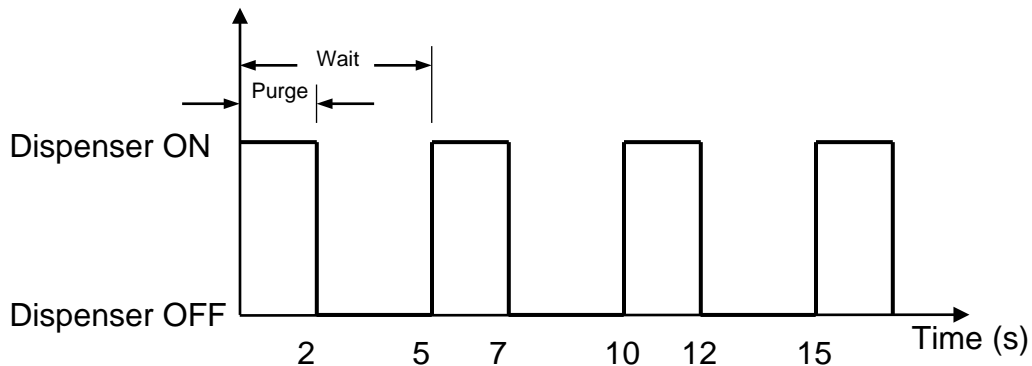

2.13 *ESTOP Output*

After receiving the emergency stop signal, the robot can set the status of all the outputs as:

- **INITIAL:** The status (On/Off) of the outputs is set as the status set by the **Initial IO** command. See Initial IO (Section 5:3.5).
- **NO CHANGE:** The status (On/Off) of the outputs is left as it was before the emergency signal.

2.14 *Acceleration*

Acceleration Setup controls the acceleration of each axis. The value entered in this setting is a robot parameter and its exact relation to the robot's acceleration is beyond the scope of this manual.

In general, the value of the acceleration parameter is inversely related to the robot's acceleration. A small value will result in a high acceleration and vice versa.

Very small values can make the motors slip and can cause the driver cards to overheat. The default value is 25 for all the axes and values lower than 15 are not recommended.

2.15 *Pause Status*

Pause Status sets the position to which the tip will move after pressing the Start button.

- **Home position:** The tip will move to the home position.
- **Stand:** The tip will stay at the position where the Start button was pressed.

2.16 *Language*

There are 6 country languages available for the memory. These are ENGLISH, CHINESE, DANISH, FRENCH, GERMAN, and SPANISH.

2.17 Tip Detect Position

"
This function needs to be operated with Tip Height Detect Device (optional) to set up the height of needle for detecting. After entering it, Teach Pendant will display like below.

```
Vk 'F gvgev'Rqukvqp*Cm#  
"  
"  
Z Z"eqqtf kpcvqp"  
[ ‡ "eqqtf kpcvqp"  
\ ‡ "eqqtf kpcvqp"  
Ngpi vj ‡ "  
]HB_E wttgpv'Rqukvqp"
```

"
Before entering the screen, needle needs to be moved to the Height Detect Device top, about 1-3 mm height. Then press [F1] to record the current needle position. Although XYZ coordination will change, the only thing needed to change is the detected length to the certain point. Normally input 2-4mm.

"
"
"
"
"
"
"
"
"
"
"
"
"
"
"
"

2.18 Tip Detect Offset

"
Be sure that Height Detect Device (optional) prepared and Tip Detect Position set up well so that the setting of reference value for needle height can begin next. Teach Pendant will display:

```
Vkr 'F gvgev\ "qhtugv"CNH"  
"  
"  
\  
"qhtugv<, , , , "  
"  
"  
"  
]HB_Cwq'F gvgev"
```

Tip height detect position setting finished, so next step is to have a relative Z axis reference value to the needle. Press [F1] Auto Detect to make needle move to the position of reference value and carry out depth detecting. It depends on your setting of Length for Tip detect position.

After setting reference value, you can start Tip height detect and Z offset in Run mode. When return home point under the Run mode then press [F1], the display of Teach Pendant is as below.

```
]Twp"O gpw_ " " " " " " " " " " " 313"  
30 Tgugv'E qwpvgt"  
40 Cf lwu'Qtki lp"  
50 Tgrqecvg'F cvc"  
60 Vkr "\ 'F gvgev"  
70 Cf lwu'Qtkpi "D\ 'EEF "  
"  
"
```

"
"
"

Choose 4. Tip Z Detect, Needle will move to the detect position.

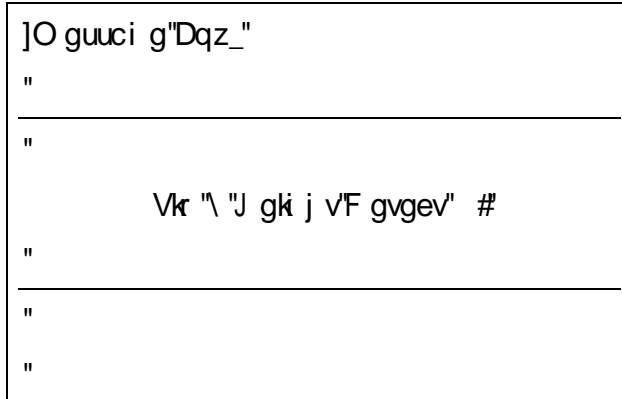

"
"

After finishing height detect, the screen will show Z axis offset which needs to be proceeded.

"

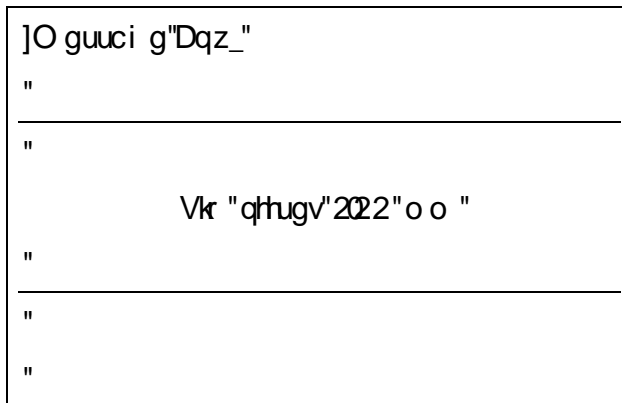

"

Eqo r rgvg#

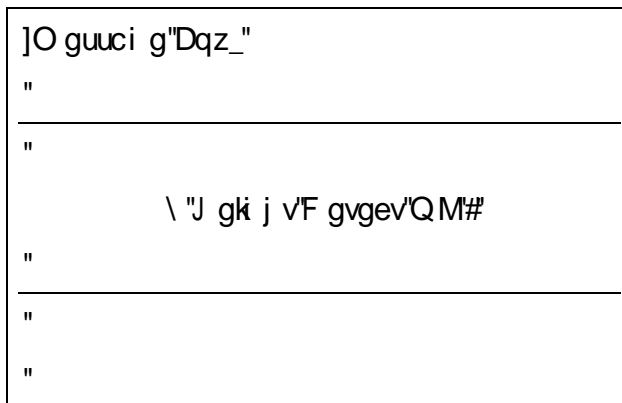

"

If length is not enough, there will be a display like below. It needs to be adjusted in the menu of Tip Detect Position.

```
]O guuci g"Dqz_"  
"  
-----  
Cf f tguu3"  
Vkr "F gvgev"hcck#  
"  
-----  
"  
]H3_QM'
```

"

2.19 Running Home First

There are two choices inside.

- (1) ON
- (2) OFF

"

The initial setting is ON

"

Before programming, determine whether to normalize machine's original point. If not to normalize machine's home point, you must conduct Home position. In the condition of edited software's original point, then after the End program it will assume to the software's home original point. In the state of unchanged, when executing the program, it will first back to the machine's original point. In case you don't want it to be back to the machine's base point, turn this option off.

"

2.20 Pre Dispense Wait Time

"

Delay time to wait before dispensing. To enter the command, must add New Time parameter

- 1. Old Time: Original setting (unchangeable)
- 2. New Time: Time you would like to alter. (changeable)

"

2.21 Circle Dispense Setup

Circle dispense set is used before Circle command. It will make the finished circle dispensing in the state of not projecting glue for a period of distance on pulling the glue motion. There are two parameter references you can input in.

1. Over anglew The length of robot idling after the state of end dispensing. As calculating a circle angle, for example input 90 degree it will go a quarter circle. Input 180 degree, it will go half circle.
2. End lift heightw The height you would like to lift. You can input 1-3mm.

2.22 Dispense Output

Dispense Output Setup assigns the dispense output port number (0-8) for the line and dot under control of the line dispense setup and point dispense setup. The default dispense output port number is zero.

Programming Sample:

Address	Instruction
1	Line Dispense Setup Head Time: 0.1 Tail Time: 0.1 Node Time: 0 Tail Length: 0
2	Dispense Output: 3
3	Line Start
4	Line End
5	Line Dispense Setup Head Time: 0.15 Tail Time: 0.1 Node Time: 0 Tail Length: 0
6	Dispense Output: 2
7	Line Start
8	Line End
9	Point Dispense Setup Head time: 0.1 Tail time: 0.1
10	Dispense output: 1
11	Dispense Dot
12	Dispense Dot
	End Program

2.23 Tip Search

Used with the optional add on of the Tip Detect device.

Tip Search Function		
Tip X:X coordinate		
Tip Y:Y coordinate		
Tip Z:Z coordinate		
[F1]Base	[F2]Setup	[F3]XYZ Search

Tip Detect Device will correct for any tip offsets when tip is damaged or changed. See Tip Detect Manual for further information.

2.24 Tip Search Ext. Trigger

Function to operate the Tip Detect Device in RUN mode without the use of a Teach Pendant. See Tip Detect Manual for further information.

2.25 Soft ORG Point

The physical limits of work space are still in place but Soft ORG Point allows the user to set any point on the work area to a new (0, 0, 0) point.

Soft ORG Point Setup	
X: X coordinate	
Y: Y coordinate	
Z: Z coordinate	
[F1] Current Position	[F2] Move

To set the new (0, 0, 0) point, the robot must first jog to the correct location. Once the tip is in position, click the Soft ORG Point function and click [F1] Current Position. That will save the position of the tip as the (0, 0, 0) point. The [F2] Move is there to move back to that point at any time.

3 Menu 1

3.1 Group Edit

Group Edit is a powerful utility, which allows several different functions to be applied to a user-defined group of addresses. These functions include copy, delete, move, multiply line speed, multiply dispense times, apply X Offset, apply Y Offset, and apply Z Offset.

3.1.1 Copy

For example, to use group edit to copy addresses 1 – 20 in the current program to memory address 21 - 40:

	<i>Instruction</i>	<i>Display Shows</i>
1	Press the MENU 1 key, then 1 to select <i>Group Edit</i> . The display will prompt the user to enter the starting memory address of the group to edit (From) and the ending number of the group to edit (To).	GROUP EDIT FROM:1 TO:1 (1 <-> 4000) F1: All F2: End
2	Type 1 then press ENTER to register 1 in <i>From</i> . Type 20 then press ENTER to register 20 in <i>To</i> .	GROUP EDIT 1-20 1.Copy 4.Line Speed 2.Delete 5.Dispen.Time 3.Move 6.Offset Select:
3	The <i>Group Edit</i> menu will then appear, allowing the user to select an operation to be applied to the range of points. Press 1 to select <i>Copy</i> . Then press ENTER	GROUP COPY SOURCE 1-20 Destination:1
4	The display will prompt the user to type the destination memory address where the data will be copied. Press the CLEAR key to erase the old value, then type 21 and press ENTER to select destination memory address number 21.	GROUP COPY SOURCE 1-20 Destination:21 1.Yes 2.No Select:
5	The display will now prompt the user to confirm the copy. Press 1 and then press ENTER to select Yes and perform the copy.	

3.1.2 Delete

To use group edit to delete addresses 15 – 25 in the current program:

	<i>Instruction</i>	<i>Display Shows</i>
1	Press the MENU 1 key, then 1 to select <i>Group Edit</i> . The display will prompt the user to enter the starting memory address of the group to edit (From) and the ending number of the group to edit (To).	GROUP EDIT FROM:1 TO:1 (1 <-> 4000) F1:All F2:End
2	Type 15 then press ENTER to register 15 in <i>From</i> . Type 25 then press ENTER to register 25 in <i>To</i> .	GROUP EDIT 15-25 1.Copy 5.Dispen.Time 2.Delete 6.Offset 3.Move 7.Offset to 4.Line Speed Select:
3	The <i>Group Edit</i> menu will then appear, allowing the user to select an operation to be applied to the range of points. Press 2 to select <i>Delete</i> . Then press ENTER	GROUP DELETE 1. Yes 2.No Select:
4	The display will now prompt the user to confirm the deletion. Press 1 and then press ENTER to select <i>Yes</i> and delete the data.	

3.1.3 Move

To use group edit to move addresses 10 – 20 in the current program to memory addresses 50 – 60:

	<i>Instruction</i>	<i>Display Shows</i>
1	Press the MENU 1 key, then 1 to select <i>Group Edit</i> . The display will prompt the user to enter the starting memory address of the group to edit (From) and the ending number of the group to edit (To).	GROUP EDIT FROM:1 TO:1 (1 <-> 4000) F1:All F2:End
2	Type 10 then press ENTER to register 10 in <i>From</i> . Type 20 then press ENTER to register 20 in <i>To</i> .	GROUP EDIT 10-20 1.Copy 5.Dispen.Time 2.Delete 6.Offset 3.Move 7.Offset to 4.Line Speed Select:
3	The <i>Group Edit</i> menu will then appear, allowing the user to select an operation to be applied to the range of points. Press 3 to select <i>Move</i> . Then press ENTER	GROUP MOVE SOURCE 10-20 Destination:1
4	The display will prompt the user to type the destination memory address where the data will be moved. Press the Clear key to erase the old value, then type 50 and press ENTER to select destination memory address number 50.	GROUP MOVE SOURCE 10-20 Destination:50 1.Yes 2.No Select:
5	The display will now prompt the user to confirm the move. Press 1 and then press ENTER to select Yes and move the data.	

3.1.4 Line SP (Line Speed)

To use group edit to increase all of the line speed commands in memory address range 1 – 200 by 20 %:

	<i>Instruction</i>	<i>Display Shows</i>
1	Press the MENU 1 key, then 1 to select <i>Group Edit</i> . The display will prompt the user to enter the starting memory address of the group to edit (From) and the ending number of the group to edit (To).	GROUP EDIT FROM:1 TO:1 (1 <-> 4000) F1:All F2:End
2	Type 1 then press ENTER to register 1 in <i>From</i> . Type 200 then press ENTER to register 200 in <i>To</i> .	GROUP EDIT 1-200 1.Copy 5.Dispen.Time 2.Delete 6.Offset 3.Move 7.Offset to 4.Line Speed Select:
3	The <i>Group Edit</i> menu will then appear, allowing the user to select an operation to be applied to the range of points. Press 4 to select <i>Line Speed</i> . Then press ENTER .	GROUP LINE SPEED Multiple Value:
4	The display will prompt the user to type the Multiple Value to be applied to the line speeds. For example, a value of 1.2 will increase all speeds by 20%. A value of 0.8 will decrease all speeds by 20%. Type 1.2 and press ENTER to select a multiplier of 1.2.	GROUP LINE SPEED Multiple Value:1.2 1.Yes 2.No Select:
5	The display will now prompt the user to confirm the change. Press 1 to select Yes. Then press ENTER All of the line speed instructions in the select range of points will now be multiplied by 1.2.	

3.1.5 Dispen.TM (Dispense Time)

To use group edit to increase all of the dispensing times (Point Dispense Setup) in memory address range 1 – 200 by 15%:

	<i>Instruction</i>	<i>Display Shows</i>
1	Press the MENU 1 key, then 1 to select <i>Group Edit</i> . The display will prompt the user to enter the starting memory address of the group to edit (From) and the ending number of the group to edit (To).	GROUP EDIT FROM:1 TO:1 (1 <-> 4000) F1:All F2:End
2	Type 1 then press ENTER to register 1 in <i>From</i> . Type 200 then press ENTER to register 200 in <i>To</i> .	GROUP EDIT 1-200 1.Copy 5.Dispen.Time 2.Delete 6.Offset 3.Move 7.Offset to 4.Line Speed Select:
3	The <i>Group Edit</i> menu will then appear, allowing the user to select an operation to be applied to the range of points. Press 5 to select <i>Dispense Time</i> . Then press ENTER	GROUP DISPENSE TM Multiple Value:
4	The display will prompt the user to type the Multiple Value to be applied to the dispense times. For example, a value of 1.15 will increase all dispense times by 15%. A value of 0.85 will decrease all dispense times by 15%. Type 1.15 and press ENTER to select a multiplier of 1.15.	GROUP DISPENSE TIME Multiple Value:1.15 1.Yes 2.No Select:
5	The display will now prompt the user to confirm the change. Press 1 to select Yes. Then press ENTER All of the Point Dispense Setup instructions in the select range of points will now be multiplied by 1.15.	

3.1.6 Offset

The Offset function allows all XYZ locations in a program to be shifted in the X, Y, or Z axis by a user-defined distance.

To use group edit to add 15 mm to all X axis values in memory address range 1 – 200:

	<i>Instruction</i>	<i>Display Shows</i>
1	Press the MENU 1 key, then 1 to select <i>Group Edit</i> . The display will prompt the user to enter the starting memory address of the group to edit (From) and the ending number of the group to edit (To).	GROUP EDIT FROM:1 TO:1 (1 <-> 4000) F1:All F2:End
2	Type 1 then press ENTER to register 1 in <i>From</i> . Type 200 then press ENTER to register 200 in <i>To</i> .	GROUP EDIT 1-200 1.Copy 5.Dispen.Time 2.Delete 6.Offset 3.Move 7.Offset to 4.Line Speed Select:
3	The <i>Group Edit</i> menu will then appear, allowing the user to select an operation to be applied to the range of points. Press 6 to select <i>Offset</i> . Then press ENTER	GROUP OFFSET X Offset: 0 Y Offset: 0 Z Offset: 0 Unit: mm
4	The display will prompt the user to type the X, Y, and Z offset amounts to be added to all points in address range 1 – 200. Type 15 and press ENTER to add 15 mm to the X axis values. Press ENTER two more times to leave the Y and Z offsets at zero.	GROUP OFFSET X Offset: 15 Y Offset: 0 Z Offset: 0 1.Yes 2.No Select:
5	The display will now prompt the user to confirm the change. Press 1 to select Yes. Then press ENTER 15 mm will be added to all of the X axis values in the selected range.	

3.1.7 Offset to

This function allows to be corrected automatically the offset problems which can appear when changing the tip, the barrel and/or the item to be dispensed on.

Move the tip using the original coordinates stored in program memory with the MOVE button. The next step is to jog the tip to the where it should be and the robot does all the math on all data points to align the tip/fixture with the original program

	<i>Instruction</i>	<i>Display Shows</i>
1	Press Move key. The tip will move to the saved position that was recorded in the current Address. If the new tip location is slightly different from the last tip location, you should see that the tip is not exactly at the reference point.	Move New Point X: 100 Y:100 Z: 100
2	Press the MENU 1 key, then 1 to select <i>Group Edit</i> . The display will prompt the user to enter the starting memory address of the group to edit (From) and the ending number of the group to edit (To).	GROUP EDIT FROM:1 TO:1 (1 <-> 4000) F1:All F2:End
3	Type 1 then press ENTER to register 1 in <i>From</i> . Type 200 then press ENTER to register 200 in <i>To</i> . The <i>Group Edit</i> menu will then appear, allowing the user to select an operation to be applied to the range of points. Press 7 to select <i>Offset to</i> . Then press ENTER	GROUP EDIT 1-200 1.Copy 5.Dispen.Time 2.Delete 6.Offset 3.Move 7.Offset to 4.Line Speed Select:
4	After pressing the ENTER then the display will prompt the next message.	Move the Tip to Dest. Point
5	Jog the tip to the correct location for the reference point. When the location is correct, press ENT. The program origin will be adjusted for the new tip location.	Program Data Adjusted !!!

3.2 Expand Step & Repeat

Expand Step & Repeat will expand a step and repeat instruction to the actual data it represents. For example, if the following program was created:

Before:

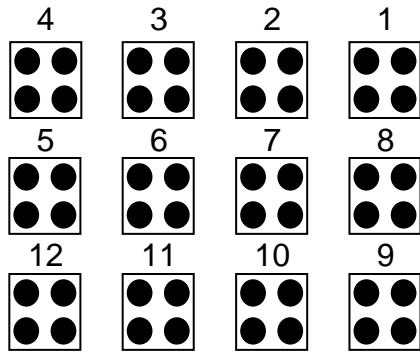

Address	Instruction
1	Dispense End Setup
2	Z Clearance
3	Point Dispense Setup
4	Dispense Point
5	Dispense Point
6	Dispense Point
7	Dispense Point
8	Step & Repeat X, Addr=4
9	End Program

The original program occupies 9 memory addresses.

If the user brings memory address number 8 into the display and then selects **MENU 1**, **Expand Step & Repeat**, address 8 will be expanded into the 44 points which it represents, bringing the total number of memory addresses used to 51 (plus the End Program instruction at address 52).

After:

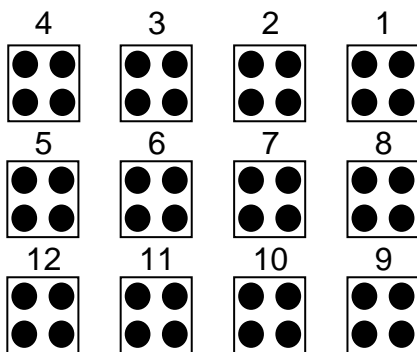

Address	Instruction
1	Dispense End Setup
2	Z Clearance
3	Point Dispense Setup
4	Dispense Point
5	Dispense Point
6	Dispense Point
7	Dispense Point
8	Dispense Point
9	Dispense Point
10	Dispense Point
.	.
.	.
.	.
51	Dispense Point
52	End Program

The Expand Step & Repeat function is useful in situations where the user must edit selected elements in a Step & Repeat group, although an expanded Step & Repeat instruction will occupy more memory space than an un-expanded instruction.

3.3 Program Name

Program Name allows the user to register a name for the current program. If a program name is registered, it will appear on the display when that program is selected in Run mode.

3.4 Z Axis Limit

Z axis Limit allows the user to limit the range of the Z axis.

Use the **Z-** and **Z⁻** keys to bring the Z axis to the lowest point the Z axis should be allowed to travel (the highest Z axis numeric value), then select **Menu 1, 4. Z Axis Limit**.

The Z axis range of motion will be limited to the current value.

3.5 Initial IO

Initial Output port sets the ON/OFF status of the output signals at the start of each program cycle.

Initial Output port value is the decimal representation of an 8 binary bit values controlling the 8 output signals.

For example,

Decimal Value	Output Status (X = on, blank = OFF)							
	#1	#2	#3	#4	#5	#6	#7	#8
0								
1	X							
2		X						
4			X					
8				X				
16					X			
32						X		
64							X	
128								X

3.6 *Debug Speed*

Debug Speed allows the debug speed to be set. This speed is the speed at which the tip will move when running in Debug mode. See also **SECTION 5:5.6 Debug Program**

3.7 *Utility Menu*

Open the Utility Menu. See **SECTION 5:4. Utility Menu.**

3.8 *Run Mode*

Determines whether the robot operates in Standalone mode (default) or Slave mode. Slave mode allows the robot to be controlled by commands send over the RS232 port. Use option 2 Slave Mode (ASCII) to connect the robot to the PC.

3.9 *Resume Program*

The resume setting will determine if a program restarts from point # 1 or from the point at which it was interrupted, such as the middle of a program.

If Resume is set to **1. On** and a program is stopped by an emergency stop signal or enclosure door switch open signal, the program will restart from the point at which it was interrupted when the start button is pressed.

If Resume is set to **2. Off** and a program is stopped by an emergency stop signal or enclosure door switch open signal, the program will restart from point #1.

The default value is **2. Off**.

3.10 *Jog Speed*

The Jog Speed setting allows the user to select the jog speed for programming in Teach mode. The Jog speed can be set to Low, Middle or High speed.

The default value is **2. Middle**.

3.11 Relocate Data

Allow the position of a program to be corrected, including correction for X offset, Y offset, Z offset and angle of rotation.

	<i>Instruction</i>	<i>Display Shows</i>
1	In this example, memory address 3 is the first reference point and memory address 4 is the second reference point. Jog the tip to the new, correct position for the first reference point.	
2	Press the MENU 2 key, and then select Save Temp Point to save the location. The display will prompt for the temporary point number to save.	Save temp point ----- Point(1-9): Relocate Save to 1,2 Point
3	Press 1 to save the first location in temporary position #1. Then press ENTER	
4	Jog the tip to the new, correct position for the second reference point.	
5	Press the MENU 2 key, then select Save Temp Point to save the location. The display will prompt for the temporary point number to save.	Save temp point ----- Point(1-9): Relocate save to 1,2 Point
6	Press 2 to save the second location in temporary position #2. Then press ENTER	
7	Press Menu 1 , and select relocate Data .	[message box] ----- Press [Enter] relocate -----
8	Tip will move to temp point 1 , then move tip to the address 3 first reference point as a new point and make offset by pressing enter.	Move to Mark1
9	Tip will move to temp point 2 , then move tip to the address 4 second reference point as a new point and make offset by pressing enter.	Move to Mark2
10	The program location will be adjusted for X offset, Y offset , Z offset and angle of rotation.	

3.12 Move Z Lifting

The Z lifting function allows the user to move through the program from point to point. For example, if the user set a (100, 100, 100) as a pre-existing point and from new point to pre-existing point, the user can simply press the move button. The tip would automatically travel down to the pre-point. When the Z Lifting function is on, before traveling down to pre-point the Z axis would rise up to the highest point, 0. But when the default value is off, before traveling down to pre-point the Z axis would only rise up for 5mm.

1. Lifting Z : ON

When Lifting Z is on, moving the tip from point to point will require the Z-axis to rise according to the specified lifting length. If lifting length is set to zero, the tip will not do a Z-axis movement to get to the next point.

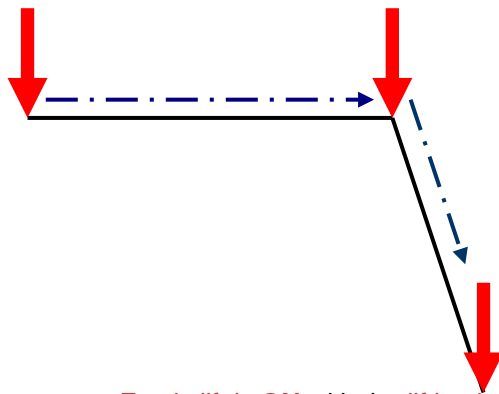

Z-axis lift is ON with the lifting length set to zero.

2. Lifting Z : OFF

When lifting Z is off, moving the tip from point to point will require the Z-axis to rise to its maximum height (Z = 0) before traveling the XY plane to get to the next point.

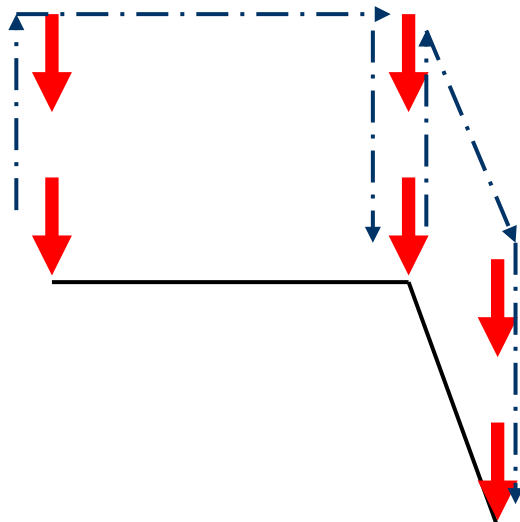

Z-axis lift is OFF so the tip moves to the home position first before going to the next point.

3.13 Z Lifting Length

The tip moves upward direction depending of the Z lifting length.

3.14 Adjust Origin

When the dispensing barrel or tip is removed and replaced, the new tip is often in a slightly different XYZ position than the old tip was. The F4200N.2 robot has a software utility to adjust a program's origin, thereby correcting the tip's offset problem.

A reference point should be chosen someplace on the work piece fixture or on the work piece itself. The reference point must be registered in the program data. This only needs to be done one time, such as when the program is originally created.

	<i>Instruction</i>	<i>Display Shows</i>
1	Press the Menu 1 key, and go to page two.	[Menu 1] 2/2 1 Run Mode 2 Resume Program . . 7 Adjust Origin
2	Press 7 to Select Adjust Origin .	----- Press [Enter] Adjust Position -----
3	Jog the tip to the reference point (i.e. X=10, Y=20, Z=30) Or if the reference point is an existing point in your program, jog the tip there and press enter on the Teach Pendant.	----- Move Tip -----

The Reference point is now set. When the tip/barrel is changed, use the following procedure to adjust the program's origin for the new tip location:

	<i>Instruction</i>	<i>Display Shows</i>
1	Press the Menu 1 key, and go to page two	[Menu 1] 2/3 1 Run Mode 2 Resume Program . . 7 Adjust Origin

	<i>Instruction</i>	<i>Display Shows</i>
2	Press 7 to Select Adjust Origin .	----- Press [Enter] Adjust Position -----
3	Jog the tip to the same reference point (i.e. X=10, Y=20, Z=30) as you did previously. Or if the reference point is an existing point in your program, jog the tip there and press enter on the Teach Pendant.	----- Move Tip -----

Your program will now be offset based on the new origin point location.

4 Utility Menu

4.1 Program

Open the program utility menu. The Program Utility menu includes four options:

1. Backup	Creates a backup of the current program in reserved backup location on the memory card. A separate backup location is reserved for each program number.
2. Restore	Restores program data backed up with 1. Backup above. The current program number data is restored.
3. Clear	Erases data in the current program number.
4. Copy	Copies the current program number to a different program number.

4.2 Memory

Open the Memory utility menu. The MASTER PASSWORD is 9999.

1. Backup	Creates a backup of the entire memory contents - all program numbers. The backup is written to a reserved location on the memory card.
2. Restore	Restores the entire contents of the robot memory backed up with 1. Backup above.
3. Clear	Erases the entire contents of the robot memory. If Clear is selected, the user will be prompted for a password.

4.3 Teach Pendant

"

There are two functions inside the menu of Teach Pendant."

"

1. Backup	Can back up the program inside storage of Teach Pendant
2. Restore	Input the stored program from the Teach Pendant, the original record will be overlapped.

"

4.4 Re-rotate Data

The Re-rotate Data function allows the position of a program to be corrected, including correction for X offset, Y offset and angle of rotation.

If, for example, the work piece fixture has been changed, the program position can be adjusted automatically for the new fixture.

The Re-rotate Data function requires two reference points for the calculations. Choose two point locations from your program which will be used as reference points. For example, to relocate the program after a fixture change:

	<i>Instruction</i>	<i>Display Shows</i>
1	In this example, memory address 3 is the first reference point and memory address 4 is the second reference point. Jog the tip to the new, correct position for the first reference point.	
2	Press the MENU 2 key, then select Save Temp Point to save the location. The display will prompt for the temporary point number to save.	Save temp point ----- Point(1-9): Relocate Save to 1,2 Point
3	Press 1 to save the first location in temporary position #1. Then press ENTER	
4	Jog the tip to the new, correct position for the second reference point.	
5	Press the MENU 2 key, then select Save Temp Point to save the location. The display will prompt for the temporary point number to save.	Save temp point ----- Point(1-9): Relocate save to 1,2 Point
6	Press 2 to save the second location in temporary position #2. Then press ENTER	
7	Press Menu 1 , then 7. Utility Menu , and select Re-rotate Data .	Relocate Program ----- 1.All Points 2.Some Points SELECT:

	<i>Instruction</i>	<i>Display Shows</i>
8	Press 1 to select <i>All Points</i> . Then press ENTER	Relocate All Point S1-> S2->
9	Type 3 and press ENTER to designate memory address number 3 as reference point 1 (temp point #1).	Relocate All Point S1->3 S2->
10	Type 4 and press ENTER to designate memory address number 4 as reference point 2 (temp point #2).	Relocate All Point S1->3 S2->4
11	The program location will be adjusted for X offset, Y offset and angle of rotation.	

4.5 Lock

Lock or Unlock Program allows the user to protect a program from editing. If the program is locked, the user will not be able to change any of the program data. Unlocking the program will allow the data to be changed again.

4.6 Password Setup

Password Setup allows the password to be set or reset for the current program. To set the password, select **MENU1**, *Utility Menu*, **Password Setup**. The user will be prompted for a **NEW PASSWORD**. Type the new password and press **ENTER**.

If the password is left blank and **ENTER** is pressed, the password will be removed. After changing or resetting the password, the robot power should be turned off.

The purpose of the password is to protect the program from unauthorized editing. The user will not be allowed to enter TEACH mode unless the correct password is entered. If the password is forgotten, the master password (8888) can be used to gain access to the program.

4.7 Cycle Counter

When in run mode, the first line of the display shows the number of program cycles which have run to completion for the current program number: [RUN MODE][X]

It is possible to reset this number by selecting **MENU1, Utility Menu, Cycle Counter**. When prompted for the **New Data:**, press **0** and **ENTER** to reset the cycle counter.

It is also possible to cause an alarm to be generated after a fixed number of program cycles. Select **MENU1, Utility Menu, Cycle Counter**. When prompted for the **New Data**, type the number of program cycles to complete before generating the alarm and press **ENTER**.

In run mode, when the set number of program cycles has been completed, the display will show **Counter Full !** and the start button will be disabled. The machine must be powered off and the Cycle Counter must be reset before the program can be run again.

4.8 Key Beep

Key Beep allows the user to set the key sound enable or disable on the Teach Pendant.

4.9 Test Function

The F4200N Series robots offer the convenience of the Test Function command.

The Test Function is a diagnostic command used for troubleshooting your robot easily through the robot Teach Pendant.

Instructions

- 1) After initializing the robot, press the *Menu1* button on the Teach Pendant.
- 2) Select *Utility Menu* (see below).
- 3) Select *Test Function* (see below).

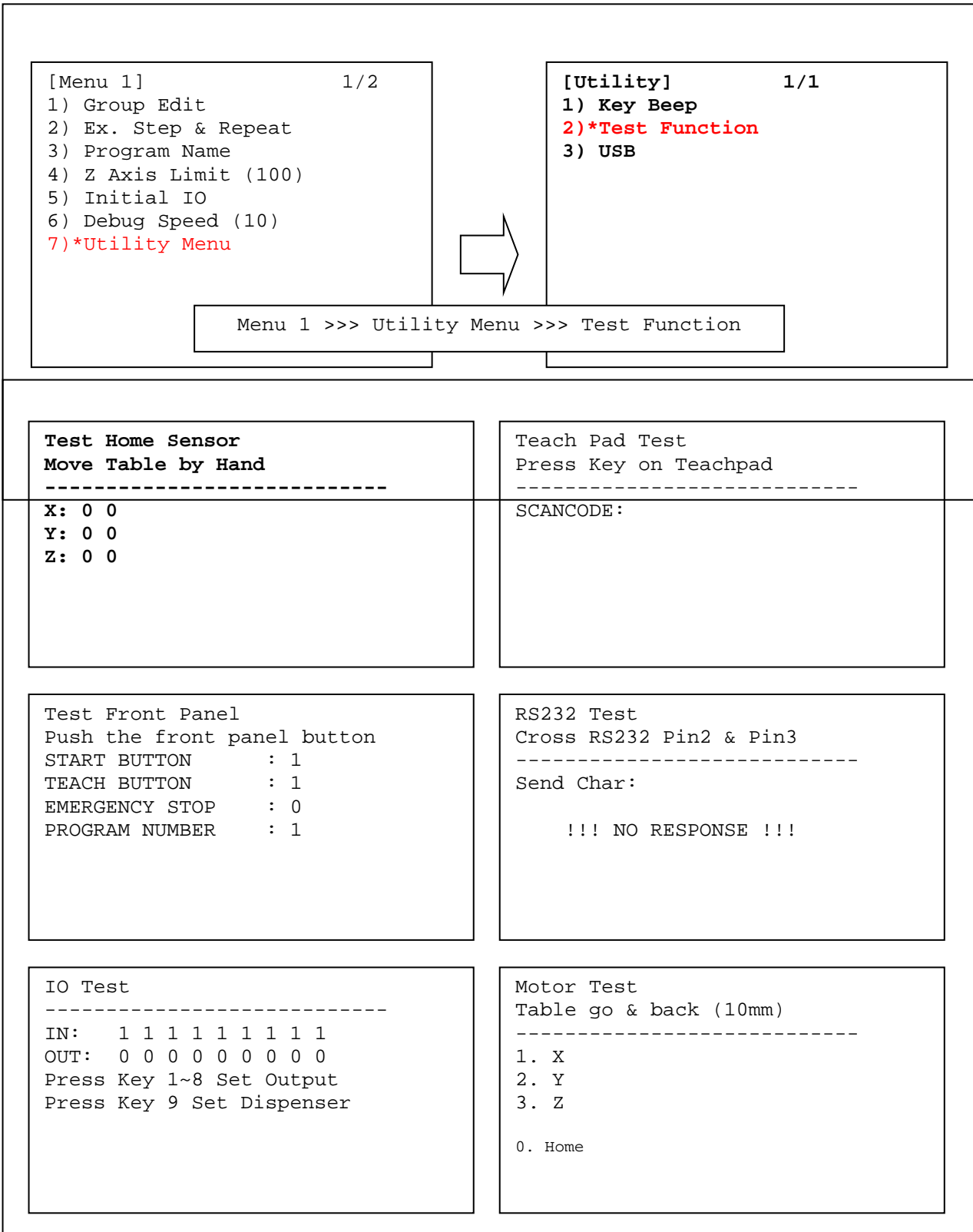

4.10 USB

The F4200N Series robots offer the convenience of a Universal Serial Bus (USB) port.

With this feature, you may load or save your programs directly to and from the robot with a USB flash drive. Updating and backing up the Operating System of the robot can also be done through the USB drive.

WARNING: In order to prevent corruption or loss of data, please make sure that the robot is turned off prior to connecting and/or disconnecting the USB drive to its port.

Instructions

1. Connect the USB to its port as shown above.
2. After initializing the robot, press the USB button as highlighted below.
3. The corresponding menu should appear on the teach pendant screen.

[USB Utility]

- 1) Load Program From USB
- 2) Save Program To USB
- 3) Update OS from USB (Password: 8888)
- 4) Backup OS to USB

Automatic Upload/Download :

Upload:

1. Plug the thumb drive to PC and add a folder called “setup”.

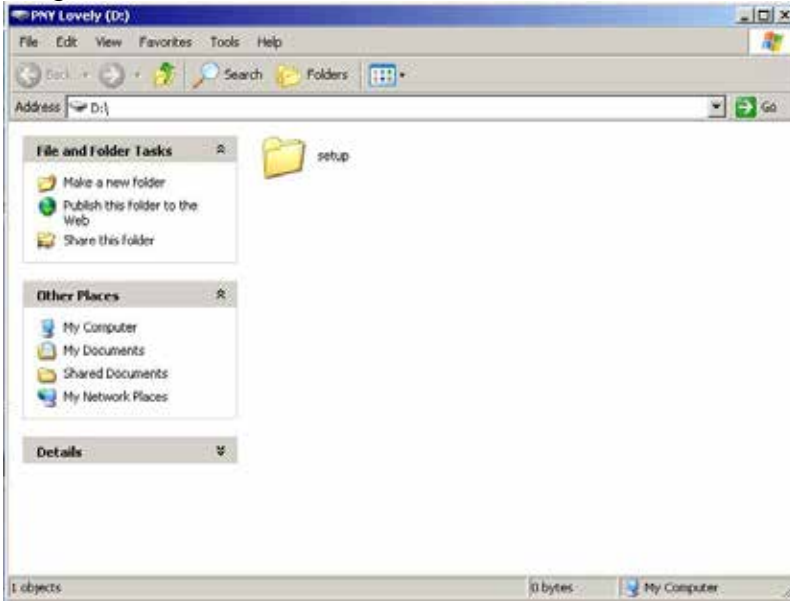

2. Place the updating files into “setup” folder. For example, LF.exe.

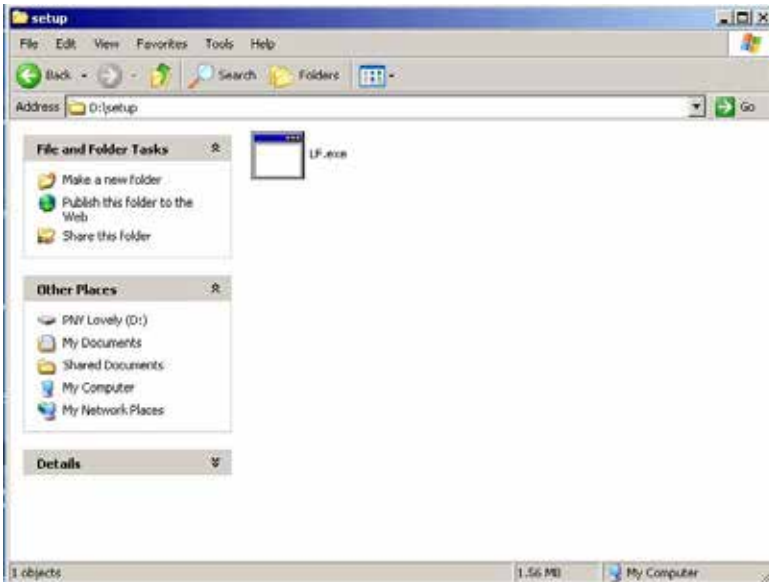

3. Plug the thumb drive to the robot and then switch on the robot.



4. When the robot is switched on and runs through its boot sequence, the software will check to see if the USB thumb drive exist in USB port or not. if USB port recognizes thumb drive, it will auto search the "setup" folder and copy every file from "setup" folder into F4200N system disk. After all files are successfully copied the robot will then auto run the If.exe file.

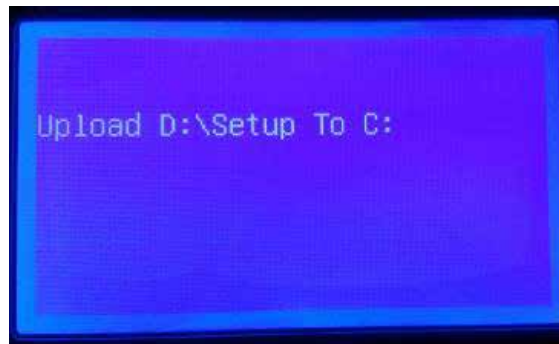

5. Successful upload is confirmed by an internal buzzer beep and executing running process.

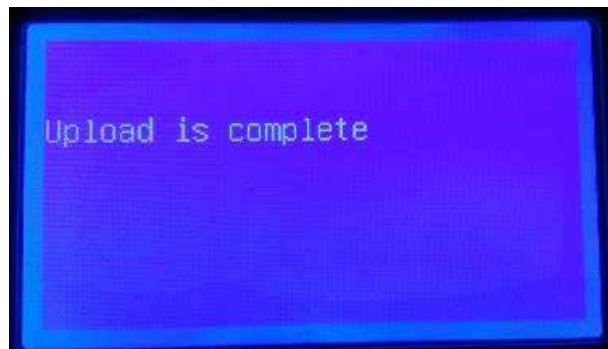

Download :

1. Plug the thumb drive to PC and then add a new folder named "BACKUP".

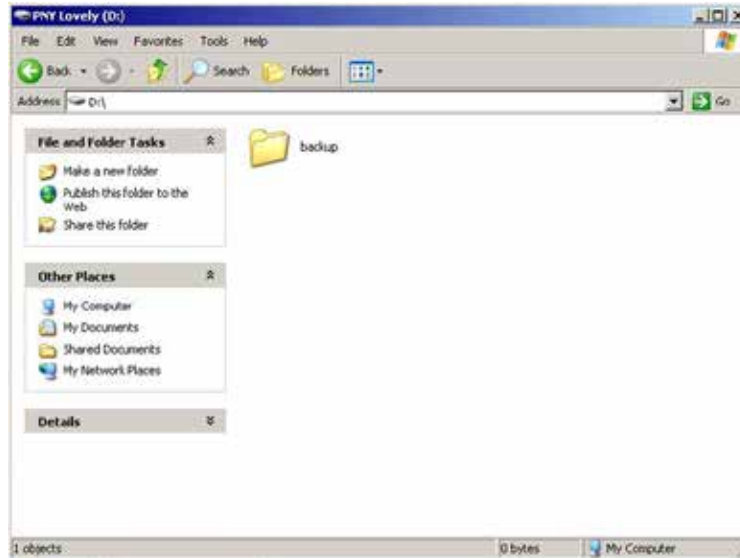

2. Plug the USB thumb drive into the USB port on the robot and then switch on the robot.



- When the robot is switched on and runs through its boot sequence, the software will check to see if the USB thumb drive exists in USB port or not. If USB port recognizes thumb drive, it will auto search the "backup" folder and copy every file from F4200N system disk into the "backup" folder of the thumb drive. After all files are successfully copied the robot will auto run the lf.exe (to execute the robot boots step).

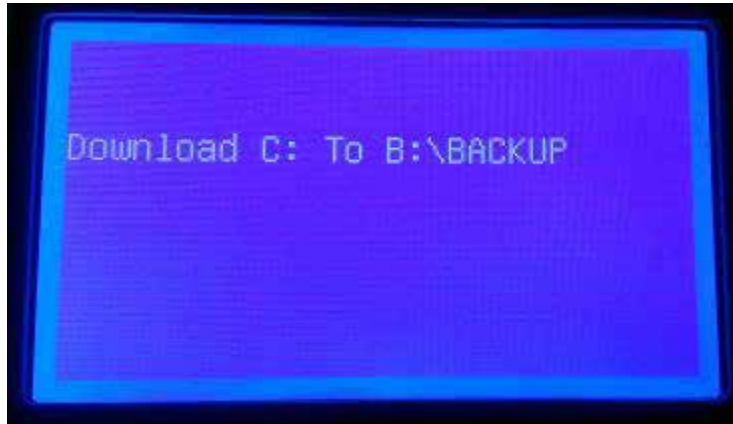

- Successful upload is confirmed by an internal buzzer beep and executing running process.

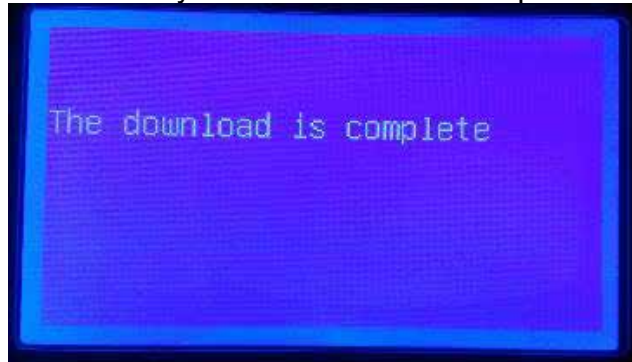

Warning:

When the thumb drive has Setup and Backup folders at the same time, only the upload function would be executed, in order to avoid any confusion on the upload and download, please have only one folder on the thumb drive.

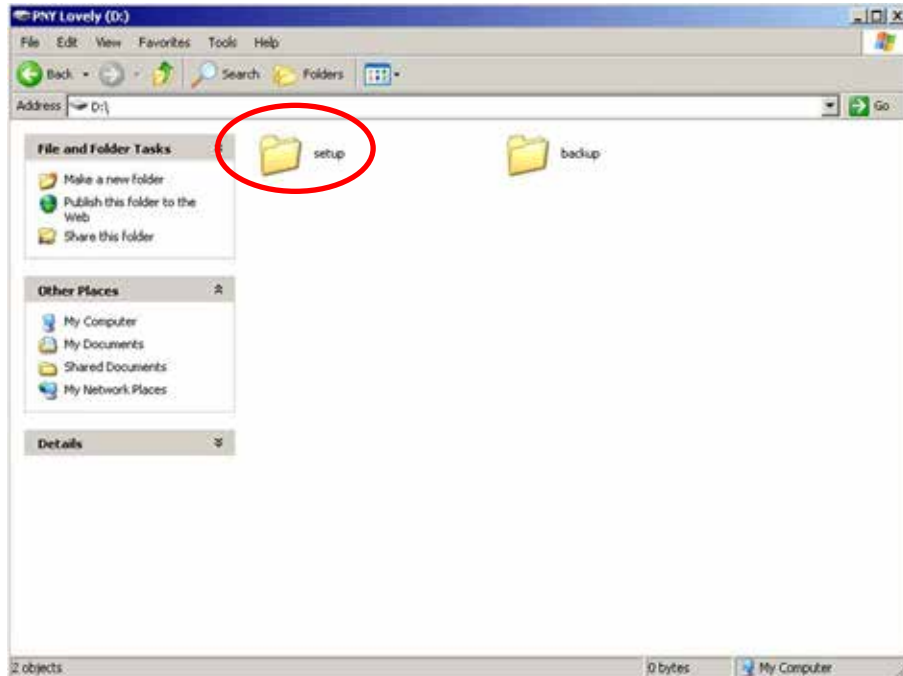

4.11 Remote Command

Remote command allows the user to operate the robot from an external device using the RS232 port.

Please refer to RS232 operating Manual for further information.

4.12 Program Capacity

Program Capacity allows the user to set a maximum point number in the program. If less point numbers are in the program number, the IPC processor is worked faster. A point limit of up to 50,000 points is possible, but the processor will be worked harder. The default value is set to 500 on the robot.

4.13 Online Signal

This function is used with Warning Flasher (optional). There are two choices:

1. ON
2. OFF

Original setting is OFF.

If choose ON, output will work automatically, its motion as below.

Qwr w'r qtv"	Y j gp"qwr w'y qtmu"	P qvg"
Qwr w4"	r tguu"Go gti gpe{ "uvqr "	ecp"eqppgeV'y kj "dggr ""
Qwr w5"	Gzgewg"r tqi tco "	"
Qwr w6"	Ucpcf "d{ "	"
Qwr w7"	Y j gp"pggf "r tguu" "uctv"̄ "	"

4.14 Bar Code Reader

1. Installation Steps

- 1) Update software version to LF25.3 or upper version by using Teach Pendant.

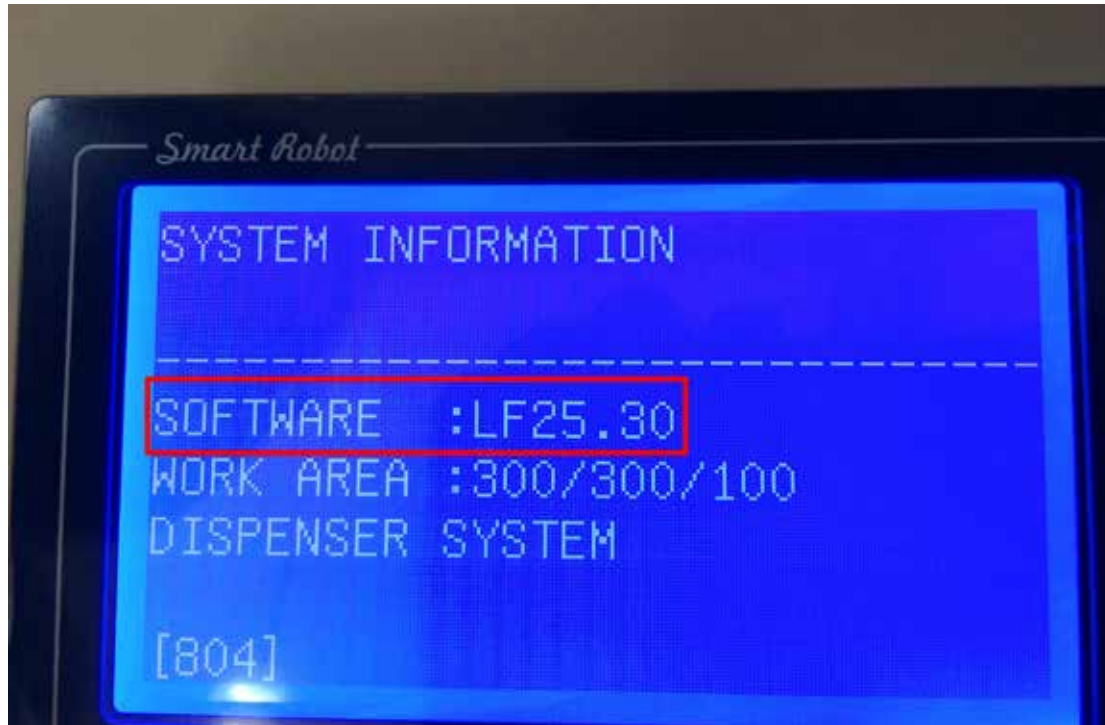

- 2) Choose "Barcode Reader".

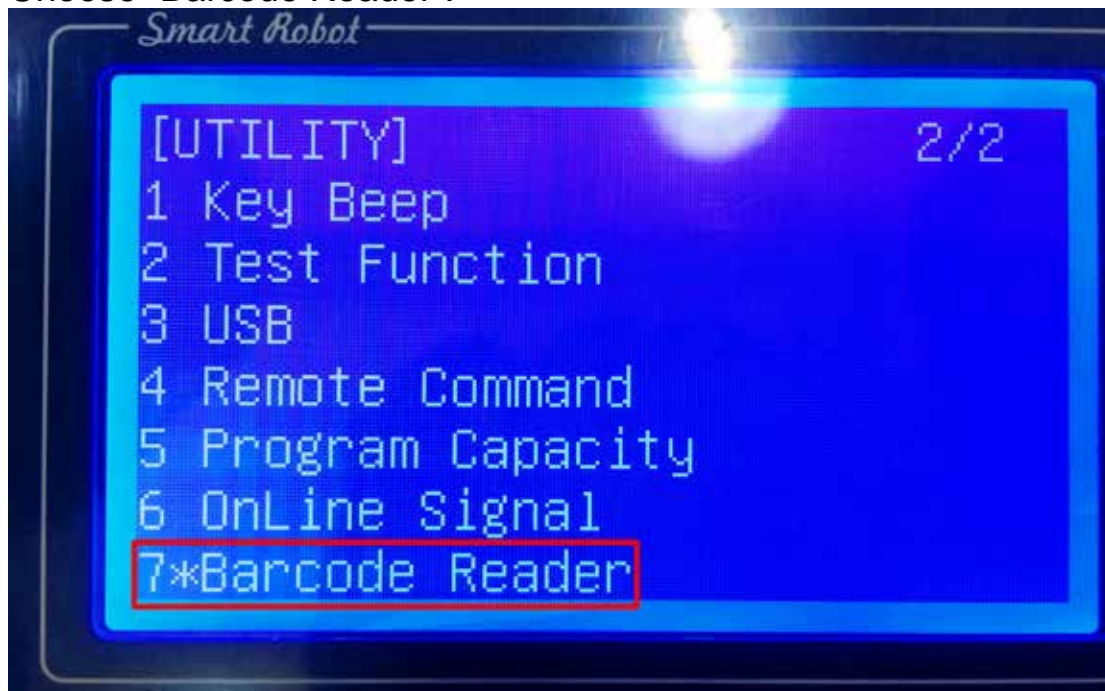

3) Select "Enable".

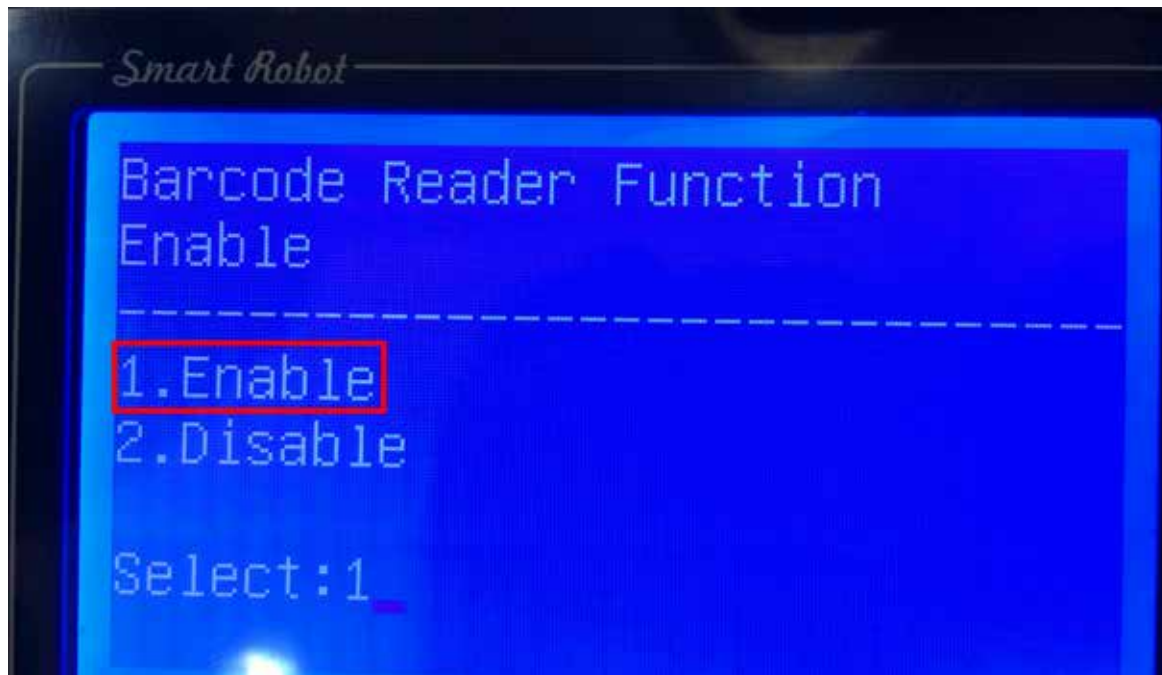

4) Connect to Barcode Reader.







5. Choose "RUN" mode.



5) Turn on the power.



2. Function List.

Function	Illustration	Description
HOME	 A barcode with the word "HOME" printed below it.	Turn to home.
CLEAR	 A barcode with the word "CLEAR" printed below it.	Remove all data.
DELETE	 A barcode with the word "DELETE" printed below it.	Delete the last information you chose.
RUN	 A barcode with the word "RUN" printed below it.	Carry out

3. Operation

1) If you want to carry out PROG_1, please scan  ;

2) If PROG_2, please scan  ;

3) If PROG_3, please scan  and so on.

4) If you want to carry out program from PROG_1 to PROG_3 at the same time,

you just need to scan    in order,

and then scan .

3) If you want to delete last information, scan  to remove it.

4) If you want to delete all data, scan  to finish it.

5 Menu 2

5.1 Numerical Move

Allow the tip to be positioned numerically by entering a number for the X, Y and Z values.

5.2 Save Temp Point

Save Temp Point saves the current XYZ position in a temporary memory area numbered (1 – 9). The save temp point function is also used with the Relocate Data function. See **SECTION 5: 4.4 Re-rotate Data**.

5.3 Retrieve Temp Point

Retrieve Temp Point retrieves a XYZ position that was stored with Save Temp Point.

5.4 Undo Program

Cancel the last change to the program. Returns to the program state prior to the last change.

5.5 Redo Program

Re-do the last change to the program that was canceled with Undo.

5.6 Debug Program

Run the program in Debug mode, using the speed set in Debug Speed starting at the current point location.

5.7 Home Position

Home Position will move the tip to the home location using either the default values (X=0, Y=0, Z=0) or the user-specified location defined in the *Setup " Home Position* command. This command cannot be used as a program instruction. It can be used during program editing to confirm the location of the home position.

5.8 System Information

System information will display the dispensing Software version currently installed in the robot.

5.9 *Execute Point*

Execute Point will run a selected command. Use the & keys to locate the command that you want to execute.

For example, if you select an address containing a circle, the *Execute Point* will cause the tip to move in a circular path.

5.10 *Cycle Time*

"

The total time consumed for executing the program. Starting from the home position, the total time cost from beginning to the end of programming. The cycle time would show under the menu 2 of teach mode. And for under the run mode, it will appear to the right corner of the teach pendant.

SECTION 6: Sample Programs

1 Dots, Lines and Arcs – Sample Program

At typical program, containing dots, lines, and arcs, would appear as follows:

Addr.	Command	Notes
0001	Line Speed (50 mm/s)	Sets the line speed to 50 mm/sec
0002	Line Dispense Setup - Head Time: 0.30 sec - Tail Time: 0.25 sec - Node Time: 0.10 sec - Tail Length: 5mm	Sets a wait time of 0.30 seconds at the start of all lines to give the material time to flow before moving along the line. Sets a wait time of 0.25 seconds at the end of all lines to give the material time to stop flowing before raising the tip. Sets a wait time of 0.10 sec at line passing point with the dispenser on. Sets a length of 5mm before the end of the line when dispenser will be off.
0003	Point Dispense Setup - Dispense Time: 0.50 sec - Tail Time: 0.25 sec	Sets the dispensing time for all dots to 0.5 seconds. Sets the waiting time, after dispensing a dot, to 0.25 seconds.
0004	Dispense End Setup - H.Speed: 75 mm/sec - L.Speed: 15 mm/sec - L.Length: 10 mm	Programs the robot to rise, after dispensing dots and at the end of line dispensing. The tip will rise 10 mm (L.Length) at 15 mm/sec (L.Speed) then continue rising at 75 mm/sec (H.Speed) to the Z Clearance height.
0005	Z Clearance - 20 mm - Relative	Sets the Z Clearance value to 20 mm relative to the point location. The maximum height the tip will rise after dispensing is 20 mm above the Dot or Line End point
0006	Line Start (10, 10, 35)	Registers a Line Start point at X: 10 mm, Y: 10 mm, Z: 35 mm
0007	Line Passing (10, 20, 35)	Registers a Line Passing point at X: 10 mm, Y: 20 mm, Z: 35 mm
0008	Arc (5, 25, 35)	Registers an Arc point at X: 5 mm, Y: 25 mm, Z: 35 mm
0009	Line Passing (10, 30, 35)	Registers a Line Passing point at X: 10 mm, Y: 30 mm, Z: 35 mm

<i>Addr.</i>	<i>Command</i>	<i>Notes</i>
0010	Line End (10, 40, 35)	Registers a Line End point at X: 10 mm, Y: 40 mm, Z: 35 mm
0011	Dispense Dot (20, 20, 35)	Dispenses a dot at X: 20 mm, Y: 20 mm, Z: 35 mm
0012	Dispense Dot (20, 25, 35)	Dispenses a dot at X: 20 mm, Y: 25 mm, Z: 35 mm
0013	Dispense Dot (20, 30, 35)	Dispenses a dot at X: 20 mm, Y: 30 mm, Z: 35 mm
0014	End Program	Ends the program. Returns the tip to the home position.

2 Brush Area – Sample Program

Addr.	Command	Notes
0001	Line Speed (25 mm/s)	Sets the line speed to 25 mm/sec
0002	Line Dispense Setup - Head Time: 0.30 sec - Tail Time: 0.25 sec - Node Time: 0.10 sec - Tail Length: 5mm	Sets a wait time of 0.30 seconds at the start of all lines to give the material time to flow before moving along the line. Sets a wait time of 0.25 seconds at the end of all lines to give the material time to stop flowing before raising the tip. Sets a wait time of 0.10 sec at line passing point with the dispenser on. Sets a length of 5mm before the end of the line when dispenser will be off.
0003	Dispense End Setup - H.Speed: 75 mm/sec - L.Speed: 15 mm/sec - L.Length: 10 mm	Programs the robot to rise, after dispensing. The tip will rise 10 mm (L.Length) at 15 mm/sec (L.Speed) then continue rising at 75 mm/sec (H.Speed) to the Z Clearance height.
0004	Z Clearance - 20 mm - Relative	Sets the Z Clearance value to 20 mm relative to the point location. The maximum height the tip will rise after dispensing is 20 mm above the Line End point
0005	Brush Area - Rectangle - Brush Width: 5 mm	Sets a Rectangle area to brush with a brush width of 5 mm.
0006	Line Start (50, 10, 35)	Registers a Line Start point at X: 50 mm, Y:10 mm, Z: 35 mm. This is the top left corner of the area to be brushed.
0007	Line End (90, 60, 35)	Registers a Line End point at X:90 mm, Y:60 mm, Z: 35 mm. This is the lower right corner of the area to be brushed.
0008	End Program	Ends the program. Returns the tip to the home position.

3 Step & Repeat – Sample Program

The program below will dispense four dots on each work piece.
 There are four rows and three columns of parts loaded on the robot for a total of 12 parts.

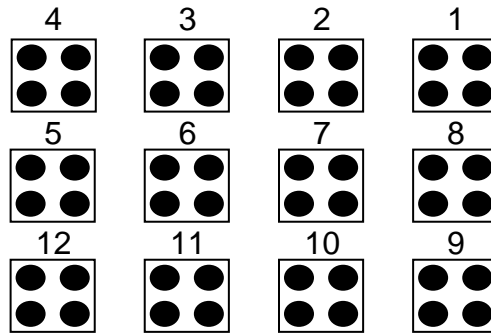

The parts are 25 mm apart in the X axis.
 The parts are 30 mm apart in the Y axis.

Addr.	Command	Notes
0001	Point Dispense Setup - Dispense Time: 0.50 sec - Tail Time: 0.25 sec	Sets the dispensing time for all dots to 0.5 seconds. Sets the waiting time, after dispensing a dot, to 0.25 seconds.
0002	Dispense End Setup - H.Speed: 75 mm/sec - L.Speed: 15 mm/sec - L.Length: 10 mm	Programs the robot to rise, after dispensing. The tip will rise 10 mm (L.Length) at 15 mm/sec (L.Speed) then continue rising at 75 mm/sec (H.Speed) to the Z Clearance height.
0003	Z Clearance - 20 mm - Relative	Sets the Z Clearance value to 20 mm relative to the point location. The maximum height the tip will rise after dispensing is 20 mm above the Dot
0004	Dispense Dot (180, 20, 35)	Dispenses a dot at X: 180 mm, Y: 20 mm, Z: 35 mm (First Part, first dot)
0005	Dispense Dot (180, 25, 35)	Dispenses a dot at X: 180 mm, Y: 25 mm, Z: 35 mm (First Part, second dot)
0006	Dispense Dot (185, 20, 35)	Dispenses a dot at X: 185 mm, Y: 20 mm, Z: 35 mm (First Part, third dot)

<i>Addr.</i>	<i>Command</i>	<i>Notes</i>
0007	Dispense Dot (185, 25, 35)	Dispenses a dot at X: 185 mm, Y: 25 mm, Z: 35 mm (First Part, four dot)
0008	Step & Repeat Y <ul style="list-style-type: none"> - Columns: 4 - Rows: 3 - X Offset: 25 mm - Y Offset: 30 mm - Start Address: 4 - 'S' Path 	Registers the Step & Repeat instruction. The robot will repeat addresses 0004 – 0007 to complete a matrix of 4x3 (12) parts. The distance between parts is 25 mm in the X axis and 30 mm in the Y axis. The robot will follow an 'S' Path, through the parts.
0009	End Program	Ends the program. Returns the tip to the home position.

4 Input / Output Signal Processing – Sample Program

The program below assumes a fixture holding 12 parts. The robot will move to the first part, then close output signal # 1 for 0.25 seconds.

The robot will then check the status of input signal #1 at the first part.

If the signal is closed, the robot will dispense a dot then move to the next part.

If the signal does not close with (2) seconds, the robot will skip this part and move to the next part. This process will be repeated for all (12) parts.

Addr.	Command	Notes
0001	Point Dispense Setup - Dispense Time: 0.50 sec - Tail Time: 0.25 sec	Sets the dispensing time for all dots to 0.5 seconds. Sets the waiting time, after dispensing a dot, to 0.25 seconds.
0002	Dispense End Setup - H.Speed: 75 mm/sec - L.Speed: 15 mm/sec - L.Length: 10 mm	Programs the robot to rise, after dispensing. The tip will rise 10 mm (L.Length) at 15 mm/sec (L.Speed) then continue rising at 75 mm/sec (H.Speed) to the Z Clearance height.
0003	Z Clearance - 20 mm - Relative	Sets the Z Clearance value to 20 mm relative to the point location. The maximum height the tip will rise after dispensing is 20 mm above the Dot
0004	Dummy Point (180, 20, 25)	Registers a 'Dummy' point at: X: 180 mm, Y: 20 mm, Z: 25 mm The tip will move to this XYZ locaiton, but do nothing. This point is just above the first part in the fixture.
0005	Set INPUT / OUTPUT - Output - Port #: 1 - Status: 1	Closes output signal # 1. Output is turned 'on.'
0006	Wait Point - Time: 0.25 sec	Wait for 0.25 seconds
0007	Set INPUT / OUTPUT - Output - Port #: 1 - Status: 0	Open output signal # 1. Output is turned 'off.'

Addr.	Command	Notes
0008	Set INPUT / OUTPUT - Input - Port #: 1 - Status: 0 - GOTO Address: 12	Check the status of input signal # 1. If the input signal is closed (pin #26 is connected to ground / pin 50), the robot will go to address #0012. If input signal #1 is open (pin #26 is not connected to ground), the program will continue at address #0009
0009	Wait Point - Time: 0.20 seconds	Wait for 0.20 seconds
0010	LOOP ADDRESS - Count: 10 - Address: 8	Repeat instructions 0008 – 0009 (10) times. (10) times a wait time of 0.20 seconds = 2.00 seconds.
0011	GOTO Address: 0013	If, after 2.0 seconds, the input signal never closed, goto address #0013 (Skip the dot dispensing).
0012	Dispense Dot (180,20,35)	Dispenses a dot at X: 180 mm, Y: 20 mm, Z: 35 mm (dot on the first part in the fixture)
0013	Step & Repeat Y - Columns: 4 - Rows: 3 - X Offset: 25 mm - Y Offset: 30 mm - Start Address: 4 - 'S' Path	Registers the Step & Repeat instrucion. The robot will repeat addresses 0004 – 0011 to complete a matrix of 4x3 (12) parts. The distance between parts is 25 mm in the X axis and 30 mm in the Y axis. The robot will follow an 'S' Path, through the parts.
0014	End Program	Ends the program. Returns the tip to the home position.

SECTION 7: Error Messages and Specifications

1 Error Messages

1.1 Point Closed Error

This message occurs when two adjacent line or arc points are registered at exactly the same XYZ location.

Do not register two line points, one after the other, at exactly the same XYZ location.

1.2 Need Line Start Point

An attempt was made to register a Line Passing point, an Arc point or a Line End point without first registering a Line Start point.

Register a Line Start point before registering a Line Passing point, an Arc point or a Line End point.

1.3 Need Step & Repeat

The Expand Step & Repeat command was given but there is no Step & Repeat instruction currently in the display. Move to the Step & Repeat function you want to expand before selecting Expand Step & Repeat.

1.4 *Unlock Program*

An attempt was made to edit a program in Teach mode which is locked. The program cannot be edited until it is unlocked. Unlock the program in ***Menu 1, Utility Menu, Lock Program***

1.5 *Address Over Memory*

An attempt was made to copy data but the copy would exceed the maximum memory address.

1.6 *Move Over Memory*

An attempt was made to move data but the move would exceed the maximum memory address

1.7 *System Error*

This message indicates a problem with the CF Memory card. Please contact your dealer.

2 I/O Specifications

2.1 Dispenser Connector:

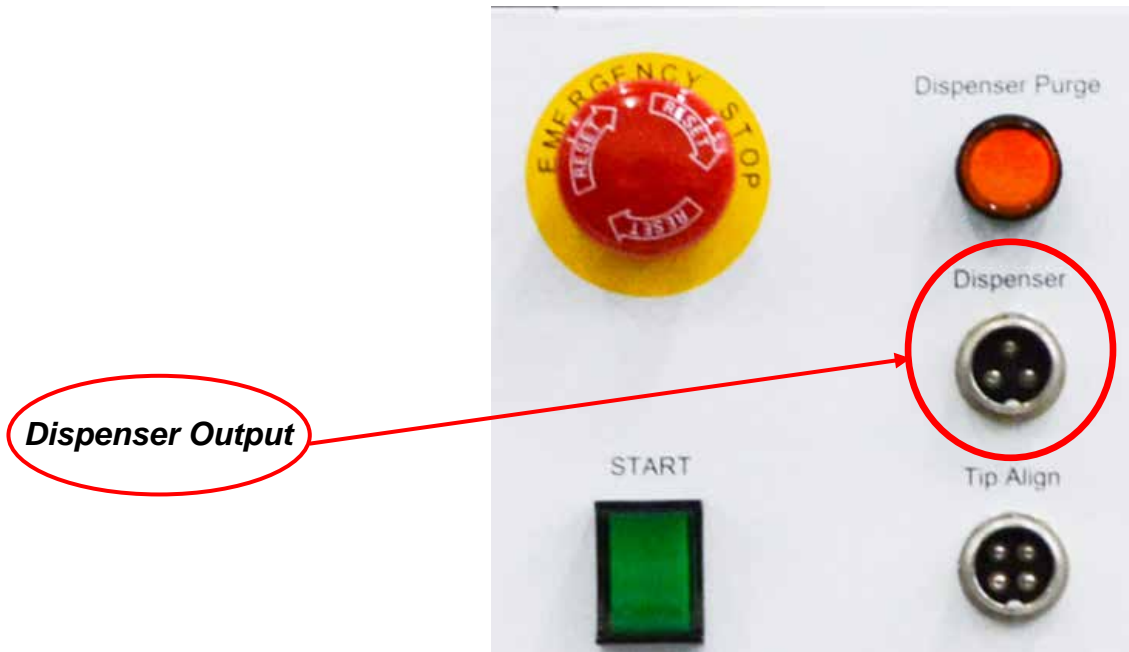

<u>Pin#</u>	<u>Description</u>
<u>1</u>	<u>NOM (Normally Open)</u>
<u>2</u>	<u>COM (Common)</u>
<u>3</u>	<u>EARTH (Ground)</u>

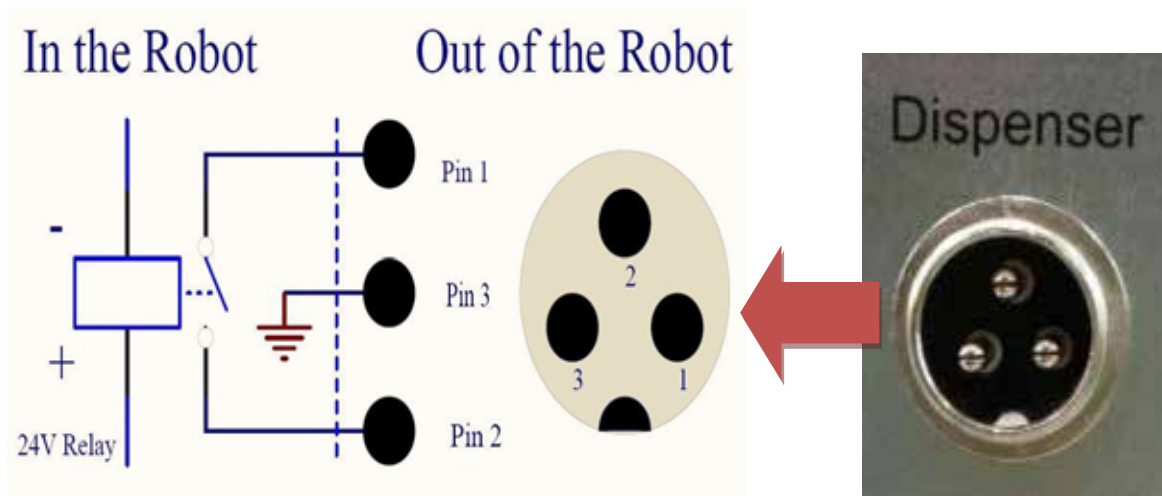

Notes:

<i>Maximum Voltage</i>	<i>Maximum Current</i>
<i>125 VAC</i>	<i>15A</i>
<i>250 VAC</i>	<i>10A</i>
<i>28 VDC</i>	<i>8A</i>

2.2 Ext. Control Connector:

The pin assignments for the external control connector are as follows:

<i>Pin #</i>	<i>Description</i>
<i>1</i>	<i>GND</i>
<i>2</i>	<i>Start Signal</i>
<i>3</i>	<i>Door Switch (COM)</i>
<i>4</i>	<i>Door Switch (NC)</i>
<i>5</i>	<i>Teach / Run</i>
<i>6</i>	<i>Emergency Stop In</i>
<i>7</i>	<i>Emergency Stop Out</i>
<i>8</i>	<i>+24V DC</i>
<i>9</i>	<i>Purge Signal</i>



External Control Connector

Shorted External Control Connector

2.3 Output Signals

<i>Pin #</i>	<i>Description</i>
<i>14</i>	<i>OUT #1</i>
<i>15</i>	<i>OUT #2</i>
<i>16</i>	<i>OUT #3</i>
<i>17</i>	<i>OUT #4</i>
<i>18</i>	<i>OUT #5</i>
<i>19</i>	<i>OUT #6</i>
<i>20</i>	<i>OUT #7</i>
<i>21</i>	<i>OUT #8</i>
<i>22</i>	<i>Reserve</i>
<i>23</i>	<i>Reserve</i>
<i>24</i>	<i>+24V</i>
<i>25</i>	<i>+24V</i>

Output Type: *Photo-coupler*

Output Power:

- *F4200N output signals are able to provide a maximum of 24 volts.*
- *F4200N output signals are able to provide a maximum of 250 milliamps per pin.*

Function:

- *When the output signal is closed, the circuit between the output pin (pin # 14 - #21) and the +24 Volt power supply (pin # 24 - #25) is closed.*
- *The output pin (pin #14 - #21) is connected to the power supply GROUND.*
- *Pins #24 - #25 are all the same. They are all connected to the +24 volt power supply.*

IMPORTANT NOTES:

1. Output signals should be used only to drive external relays. Do not power external devices directly through output signals. Electrical noise will damage the output signal relay.
2. If an inductive load (such as a relay) is connected to an output signal, be sure to install a diode as shown to prevent damage to the output photocoupler:

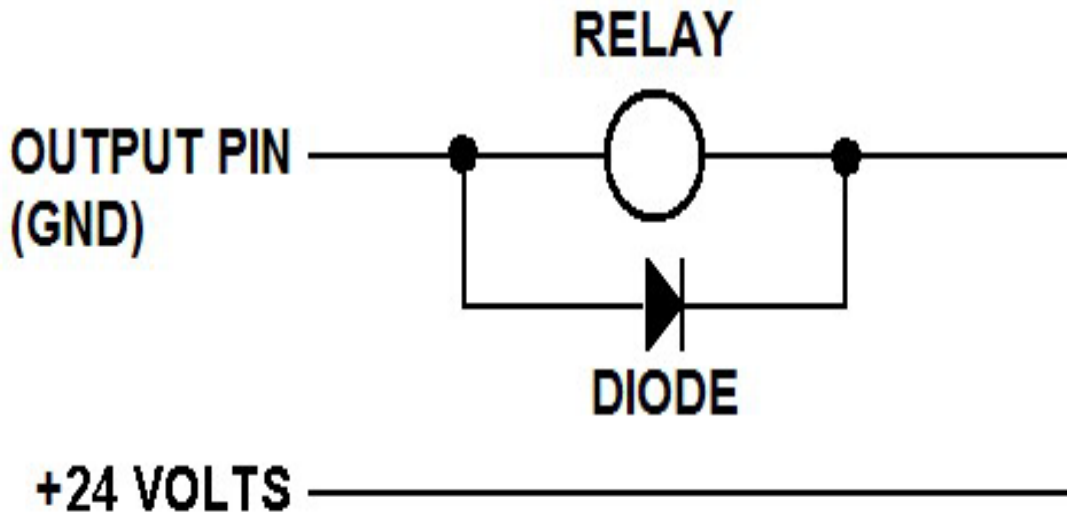

2.4 Input Signals

Pin #	Description
1	IN # 1
2	IN # 2
3	IN # 3
4	IN # 4
5	IN # 5
6	IN # 6
7	IN # 7
8	IN # 8
9	Reserve
10	Reserve
11	GND
12	GND
13	GND

Notes:

To close an input signal, short the circuit between the input pin (1 – 8) and a COM / ground pin (ANY pin # 11 - pin 13).

Input signals are powered by the robot internal power supply: 24 volts, maximum 2.5 mA

Check the status of an input signal using the SET I/O command (see **SECTION 5:1.15 – Set I/O**). When the input pin (pin1 –8) is connected to a COM pin (pin #11- #13), the value of the input is 0.



Warning: A dry contact closure between inputs and any ground will trigger an input signal. DO NOT apply a voltage between any input and ground. Doing so can damage the control board and will void the warranty.

2.5 Input / Output Schematic

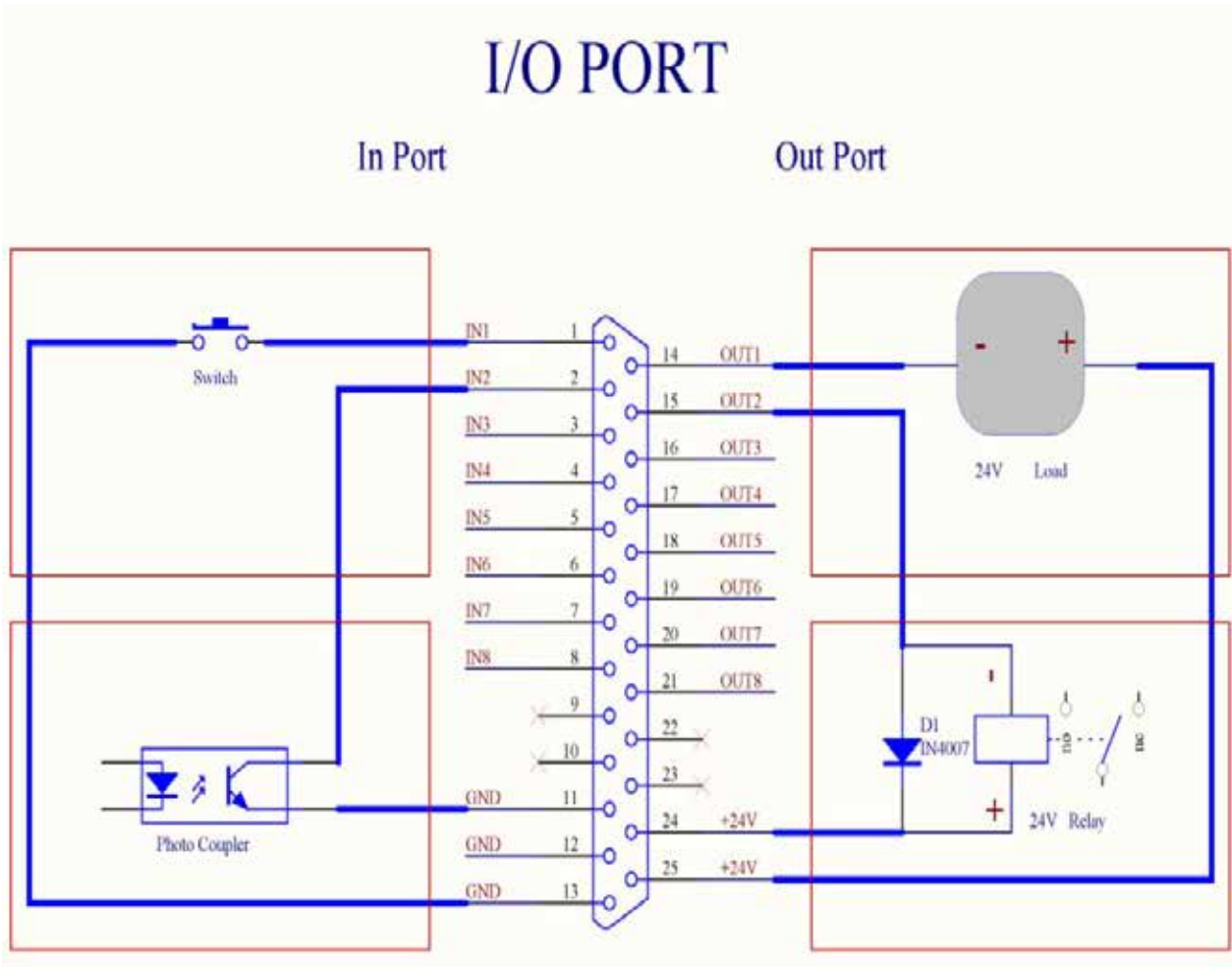

2.6 Input / Output Power Specifications

<i>F4200N.1</i>		
	<i>Inputs (Internal Power Supply)</i>	<i>Outputs (Internal Power Supply)</i>
MAXIMUM Voltage	24VDC	24 VDC
MAXIMUM Current	2.5 mA	250 mA

3 System Specifications

Item Number	F4200N.2
Working Area X/Y/Z	200 x 200 x 50mm
Maximum Speed (X&Y/Z)	500 / 200mm / secs
Work Load	3kg (7lbs)
Tool Load (Z-Axis)	2kg (4lbs)
Repeatability	+/- 0.02mm / axis
Resolution	0.001mm / axis
Motion Control	PTP & CP
Drive System	Micro stepping motors
Data Memory	1-100 programs 50,000 points / program
I/O Signals	8 inputs / 8 outputs
External Interface	USB / RS232
Power Supply	Auto-switching AC 100 - 240 VAC, 320 watts
Dimensions (W/D/H)	324 x 499 x 480mm (13 x 20 x 19")
Weight	20kg (44lb)
Approvals	CE, RoHS, WEE

4 Machine Dimensions

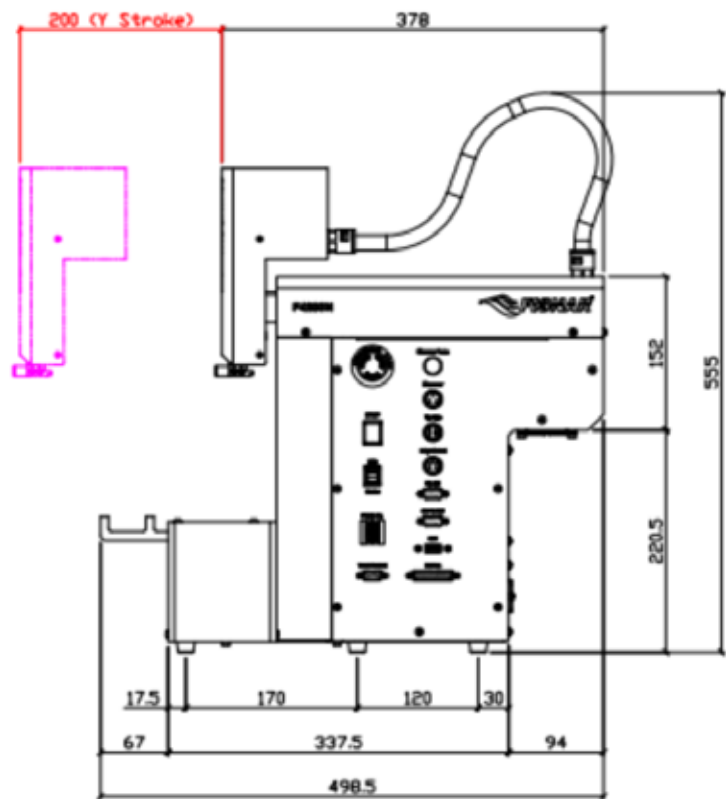
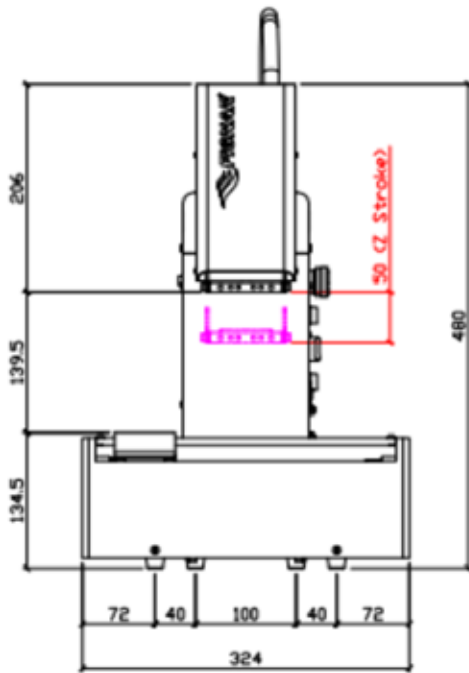
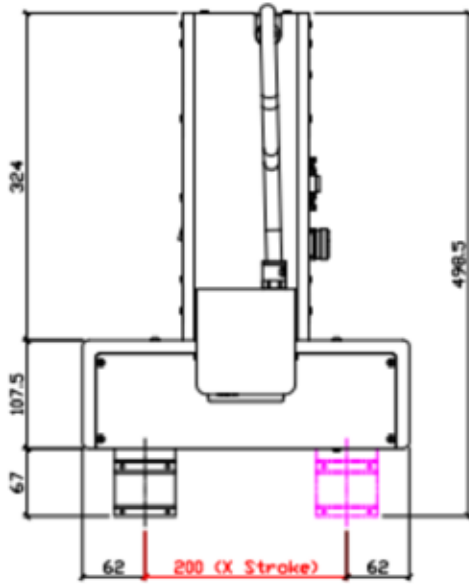

4.1 Work Table Dimensions

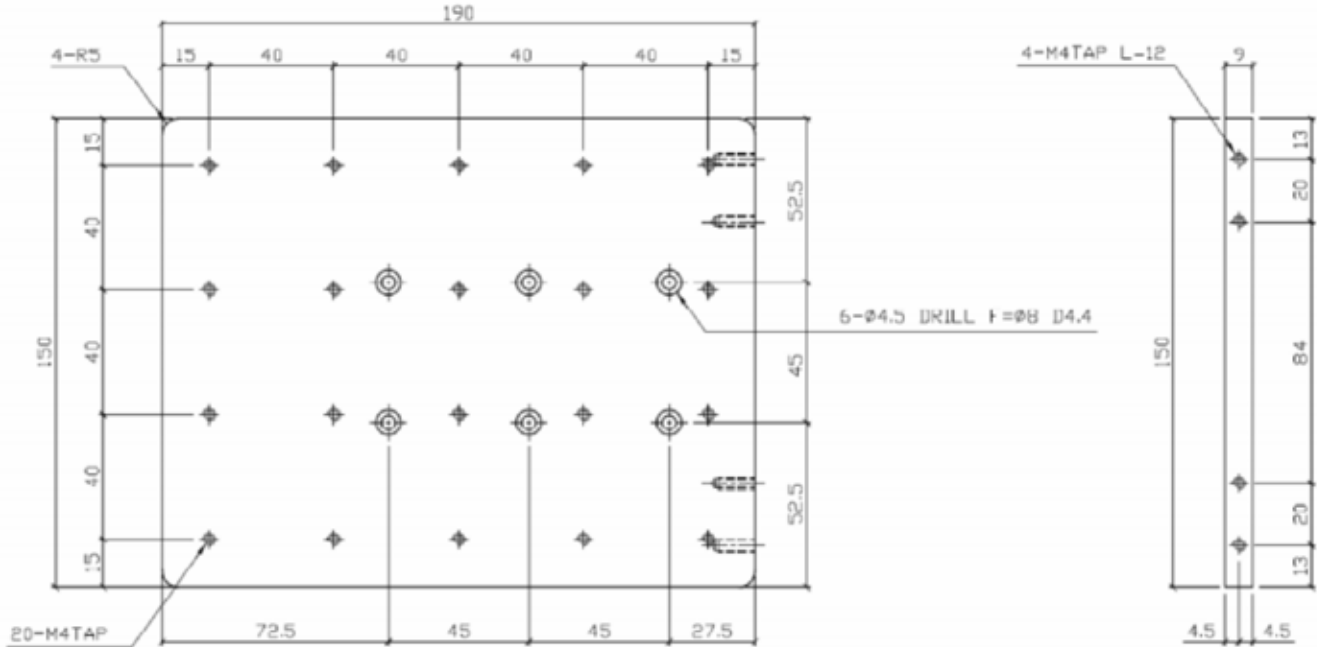

檯
檯

4.2 Z-Axis Fixing Head Dimensions

檯

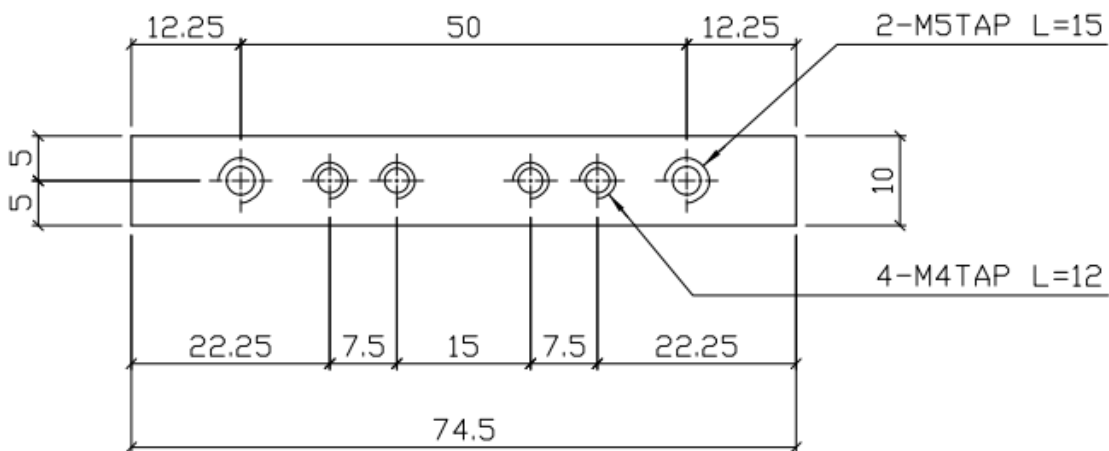

檯

4.3 X-Axis Sliding Plate Dimensions

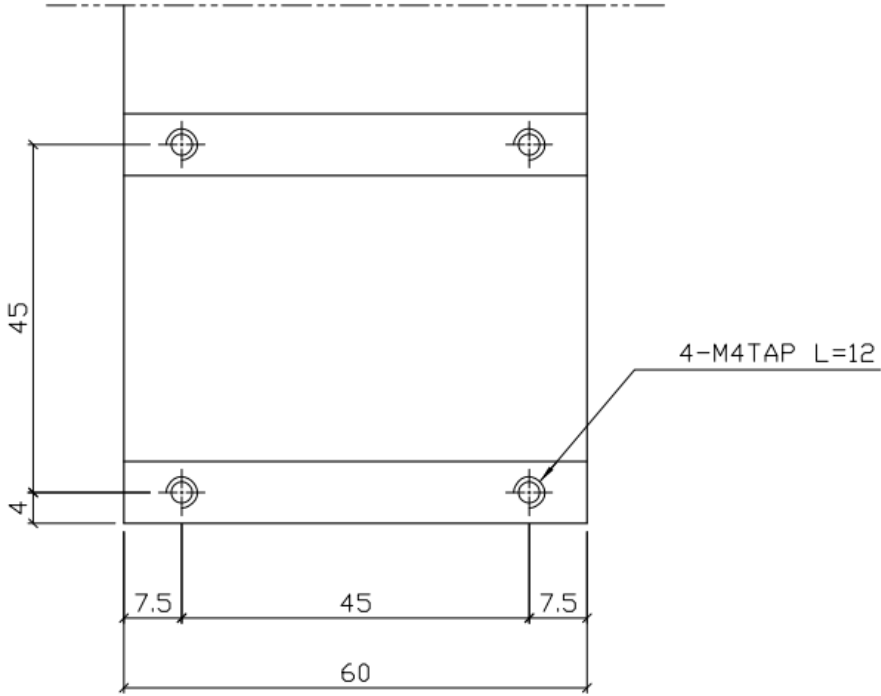

SECTION 8: Maintenance and Periodic Inspection

1 Check Cycles and Methods

1.1 General Consideration

It is essential to correctly and periodically inspect and maintain the robot to prevent unexpected failures or malfunctions, thus ensuring safe operation and lengthening the machine's life.

The outside parts of the machine should be kept clean. Use vacuum cleaner or soft cloth to clean the machine. Do not use compressed air or chemical products to clean the machine, as they can damage the internal cables, timing belts and other components of the unit.

Use only the greasing materials recommended by the manufacturer of the machine.

1.2 Check Cycles and Points

The check cycles of the machine are classified in the following categories:

- Daily check
- Weekly check
- Check after 3 months of operation
- Check after 3 years of operation

These cycles are based on a daily 8 hours of operation.

The check points are as follows:

Check point	Check cycle			
	Daily	Weekly	Every 3 months	Every 3 years
Tilt or deviation of machine	x			
Status of cables and hoses	x			
Appearance	x			
Stability on the work bench	x			
Motor running condition		x		
Motions, connections and joints			x	
Unfastened / loose bolts and screws			x	
Internal wires and connectors			x	
Accuracy and precision			x	
Ball screw assembly, LM guide, slide guide			x	
Overhaul				x

1.3 Check Methods

Check point	Check action (See if)	Corrective action
Tilt or deviation of machine	- Robot working position is tilted or inclined	- Set the machine in a proper vertical position
Status of cables and hoses	- Electrical cables and pneumatic hoses are excessively twisted, bent or squeezed - Air leakage between pneumatic hoses and fittings	- Remove the causes of twisting, bending or squeezing - Cut away the damaged parts of hoses and make new connections
Appearance	- Damage on the robot's head from clashes during operation	- Pay attention to working area of robot and remove any obstacle
Stability on work bench	- The robot is too close to the edge of the work table	- Rearrange the position of the robot on the table - Remove sources making table to vibrate
Motor running condition	- Infiltration of grease - Degradation of performance due to overload	- Replace motor (See Agent)
Motions, connections and joints	- The axes are not moving smoothly - Noises, vibrations and / or shakes	- Grease up - Reset and adjust gains (Contact Agent for setting)
Unfastened / loose bolts and screws	- Loose or broken bolts and nuts	- Tighten loose bolts and nuts. Make corrective actions to remove the causes
Internal wires and connectors	- Stripped or damaged external cover or shield on cables and / or connectors	- Replace the damaged cables or connectors with new ones (See Agent)
Accuracy and precision	- Z runout over X or Y bigger than 0.2 mm - Wear on timing belt	- Contact Agent - Replace timing belt (See Agent)

Ball screw (worm) assembly, LM guide, slide guide	- Lack of grease on shaft, LM guide and / or slide guide surfaces - Deflection of the shaft	- Apply grease on grease hole of worm, LM guide and slide guide surfaces (See Section 9: 2) - Replace the shaft (Contact Agent)
Overhaul	- Diagnose the whole system and take decision for the overhaul	- Contact Agent

2 Greasing Procedure

2.1 Grease Type and Greasing Interval

- Grease type: 30 – 100 centistokes (recommended: THK AFA 70G)
- Greasing periods: every 6 months

2.2 Accessing Parts to be Greased

1. Unscrew the bolts shown with arrows in the following pictures and remove the covers
2. Apply grease into the grease hole of ball screw (worm) and also thinly to the surfaces of LM guide and slide guide
3. Put back the covers and screw in the bolts.

F4200N.2
 X-axis

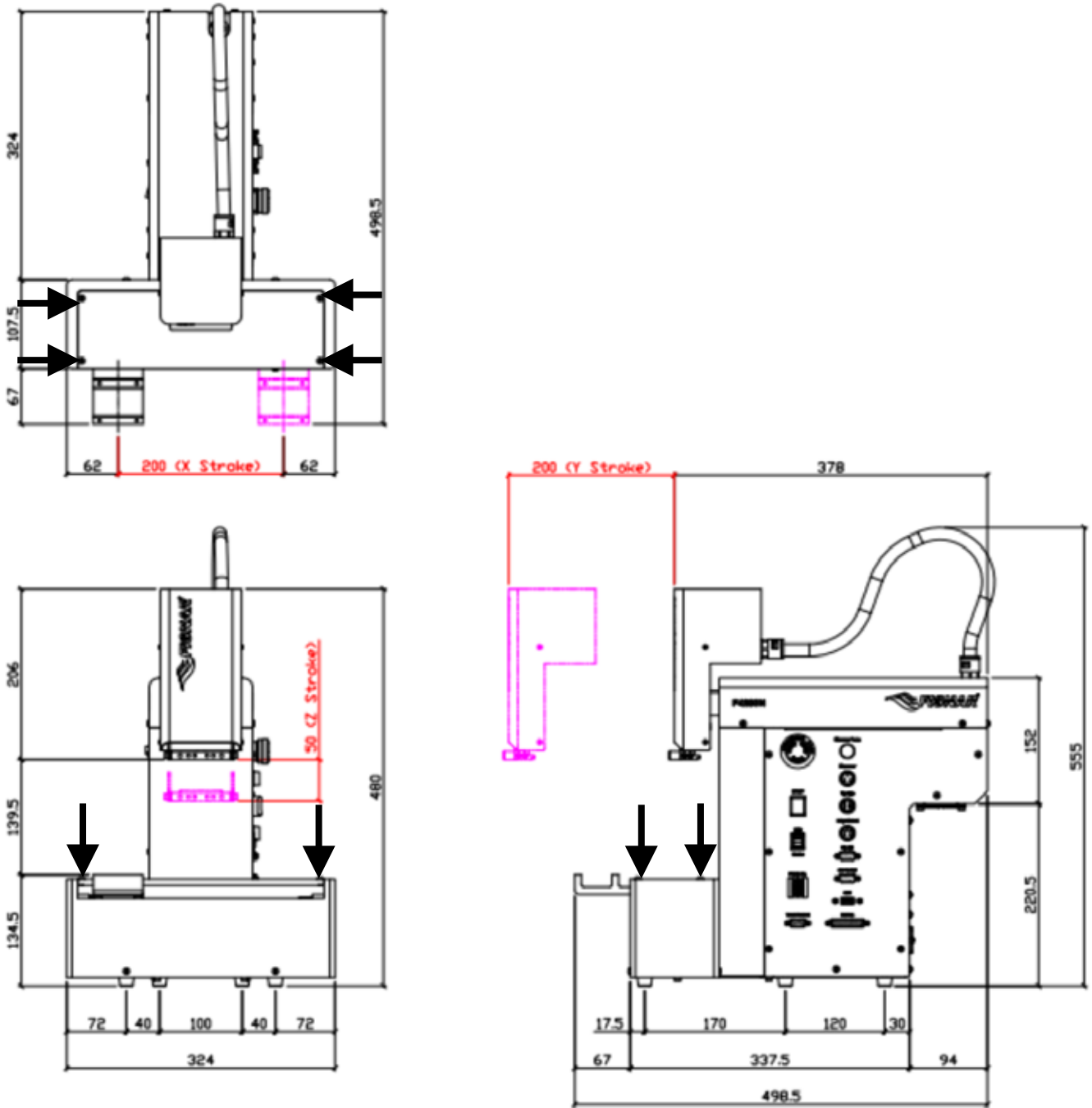

NOTE: Screws are indicated by arrows. → ↑

F4200N.2
Y-axis

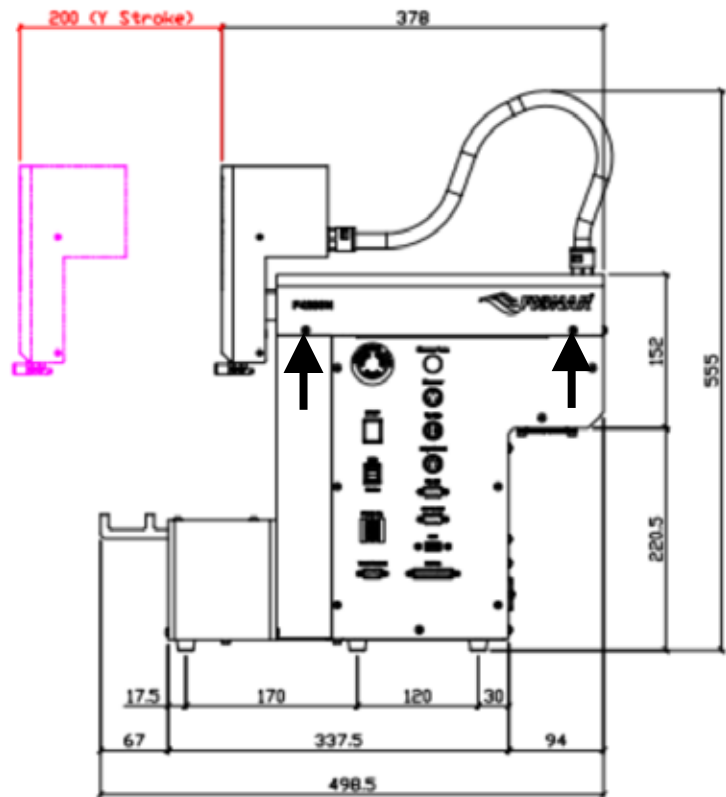
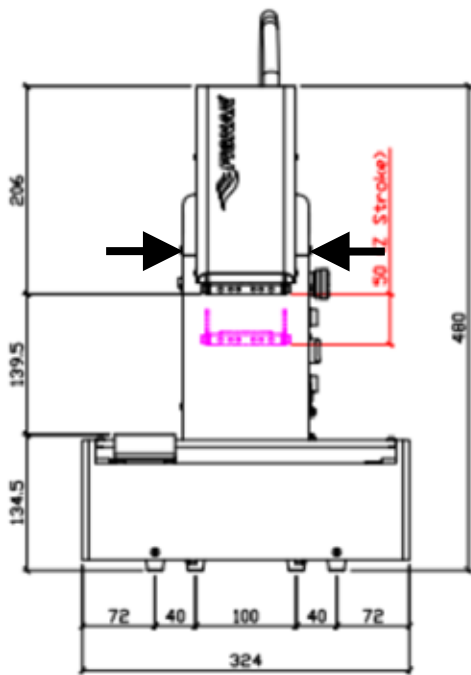
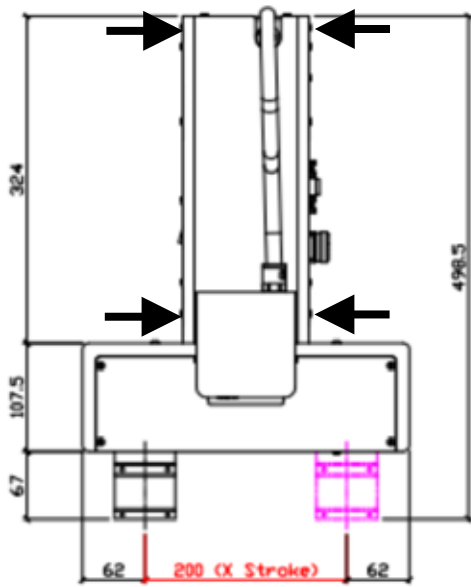

NOTE: Screws are indicated by arrows. → ↑

F4200N.2
 Z-axis

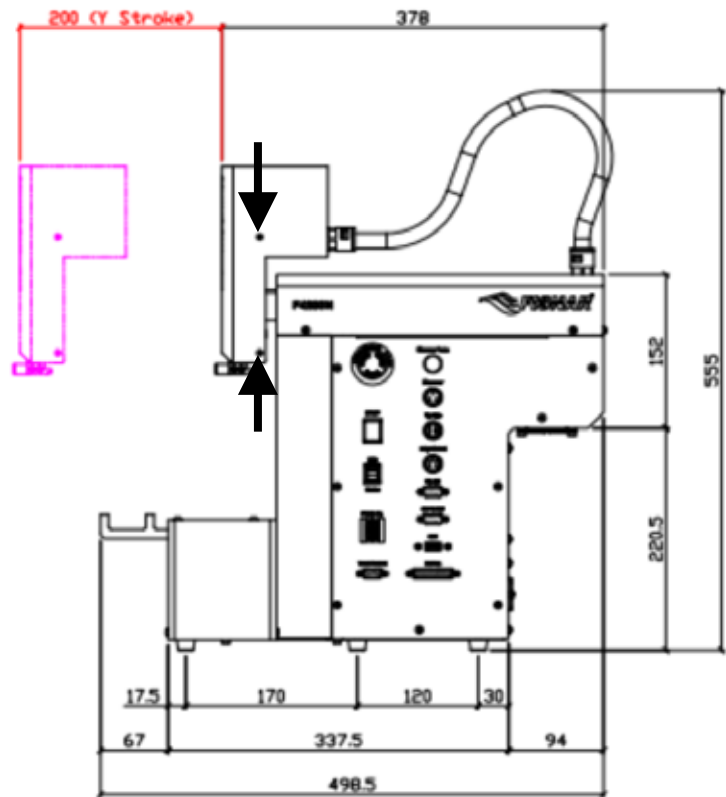
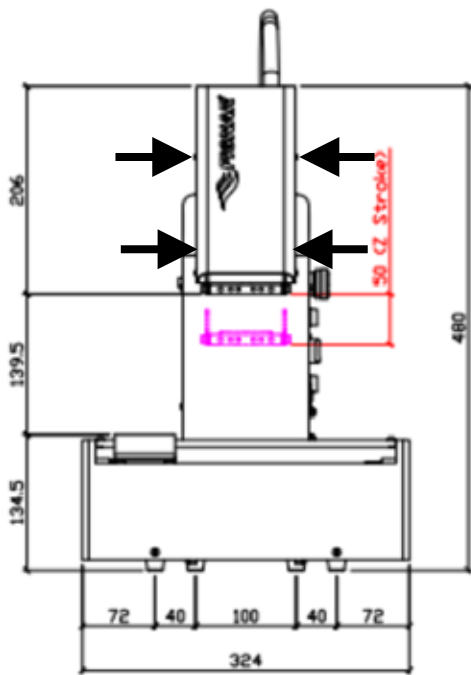
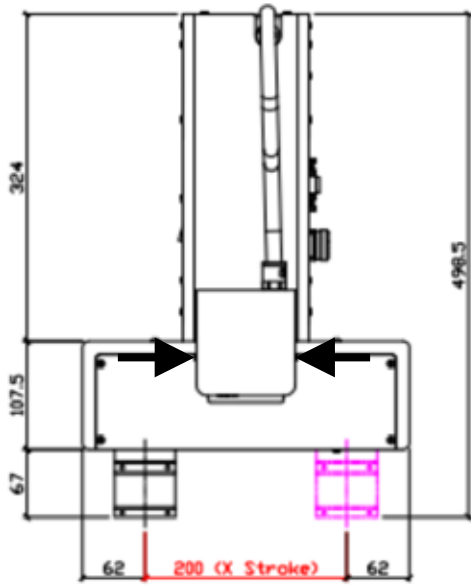

NOTE: Screws are indicated by arrows. → ↑

Mechanical Part Lists – F4200N.2

F4200N.2 Module Drawing

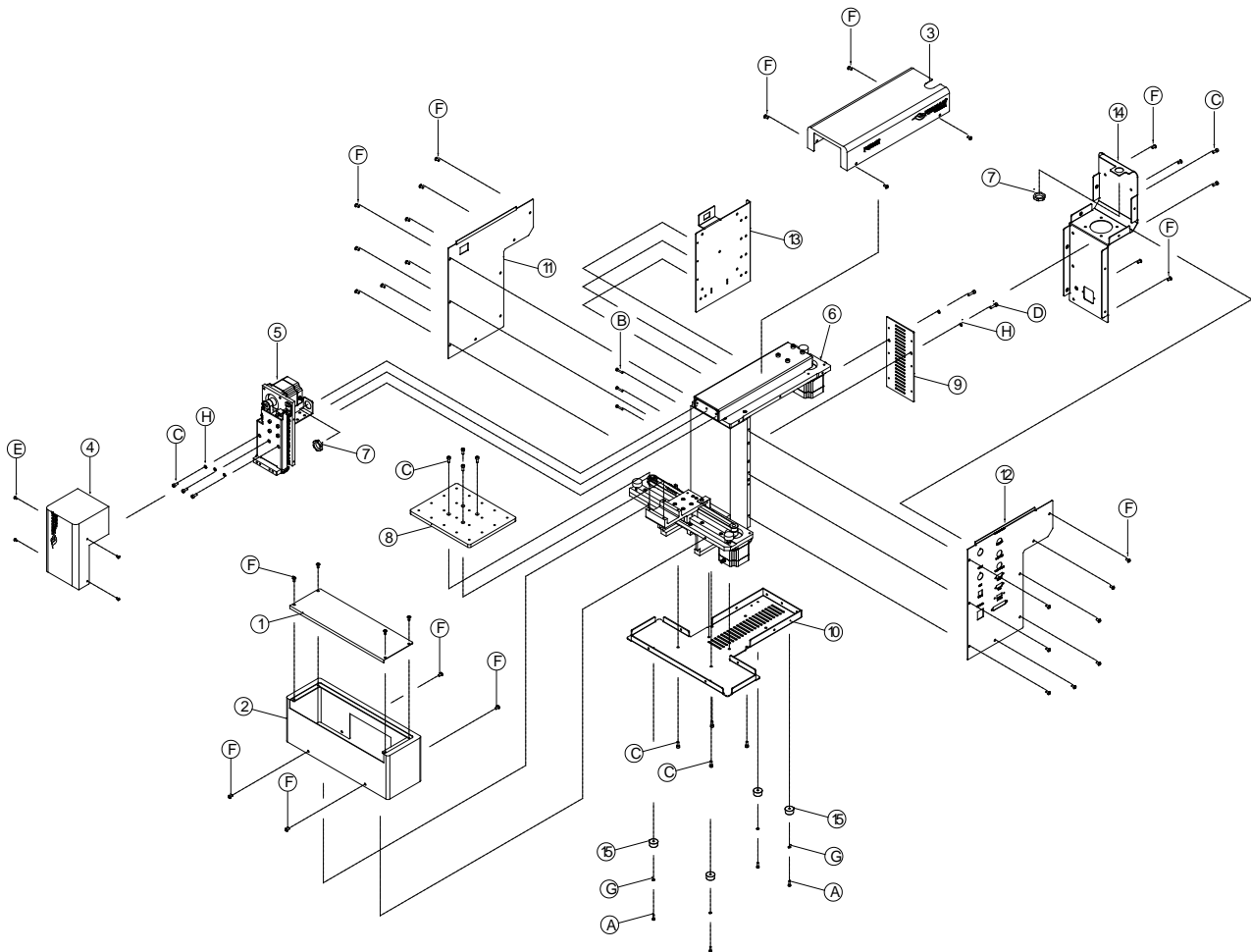

F4200N.2 Module Part List

NO.	PART NO.	ENGLISH NAME
1	1212-10210001	X UPPER COVER
2	1212-10210002	X BASE
3	1212-10210010	Y COVER
4	1212-10210011	Z COVER
5	1212-15300001	Z AXIS MODULE
6	1212-15400001	F4200N.2 BODY MODULE
7	A22WSC-JA-211PG	NUT
8	1212-10104001	WORKING TABLE
9	1212-10200001	DRIVER FIXING PLATE
10	1212-10210005	CONTROL BOX CHASSIS
11	1212-10210006	LEFT PLATE
12	1212-10210007	RIGHT PLATE
13	1212-10210008	CONTROL BOARD FIXING PLATE
14	1212-10210009	BODY REAR COVER
15	1212-10400001	CUSHION
A	W113000005	ALLOY HEXAGONAL SOCKET BOLT牛M3*10L犬
B	W113000006	ALLOY HEXAGONAL SOCKET BOLT牛M3*15L犬
C	W113000011	ALLOY HEXAGONAL SOCKET BOLT牛M4*10L犬
D	W113000012	ALLOY HEXAGONAL SOCKET BOLT牛M4*15L犬
E	W116000026	SUS CROSS BOLT牛M3*6L犬
F	W116000027	SUS CROSS BOLT牛M4*10L犬
G	W118000009	SUS SPRING WASHER牛M3犬
H	W118000010	SUS SPRING WASHER牛M4犬

F4200N.2 – X Axis Drawing

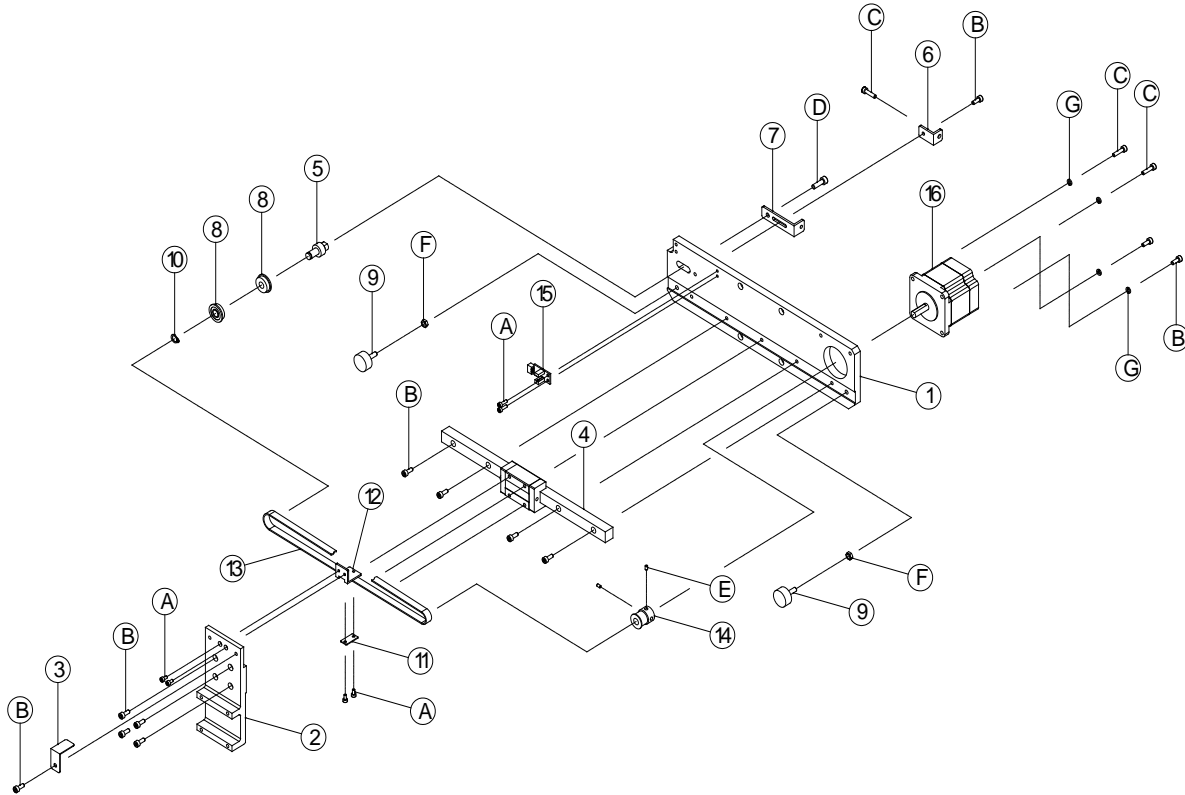

F4200N.2 – X Axis Part List

NO.	PART NO.	ENGLISH NAME
1	1212-10103001	X FIXING PLATE
2	1212-10102001	X SLIDING PLATE
3	1212-10230001	X SENSOR TRIGGER
4	1212-10303001	LM GUIDE
5	0603-20150001	X/Y IDLE PULLEY
6	0603-20230004	TIMING BELT ADJUSTING KIT
7	0603-20230005	TIMING BELT ADJUSTING KIT BASE
8	0603-20304001	BEARING
9	0603-20400001	BUFFER PILLAR
10	0603-20400003	C CLIP
11	0607-10220001	TIMING BELT FIXING PLATE
12	0607-10230001	TIMING BELT FIXING KIT
13	0607-10309001	X TIMING BELT
14	0711-10308001	X/Y/Z TIMING PULLEY (MOTOR SIDE)
15	A08DCW-0603-2-P103	OPTICAL LIMIT SWITCH
16	A21MOTOR-EH366-38	3-PHASE STEP MOTOR
A	W113000004	ALLOY HEXAGONAL SOCKET BOLT牛M3*5L犬
B	W113000011	ALLOY HEXAGONAL SOCKET BOLT牛M4*10L犬
C	W113000012	ALLOY HEXAGONAL SOCKET BOLT牛M4*15L犬
D	W113000017	ALLOY HEXAGONAL SOCKET BOLT牛M5*15L犬
E	W113000059	ALLOY SET BOLT牛M3*5L犬
F	W117000004	SUS NUT牛M5犬
G	W118000010	SUS SPRING WASHER牛M4犬

F4200N.2 –Y Axis Drawing

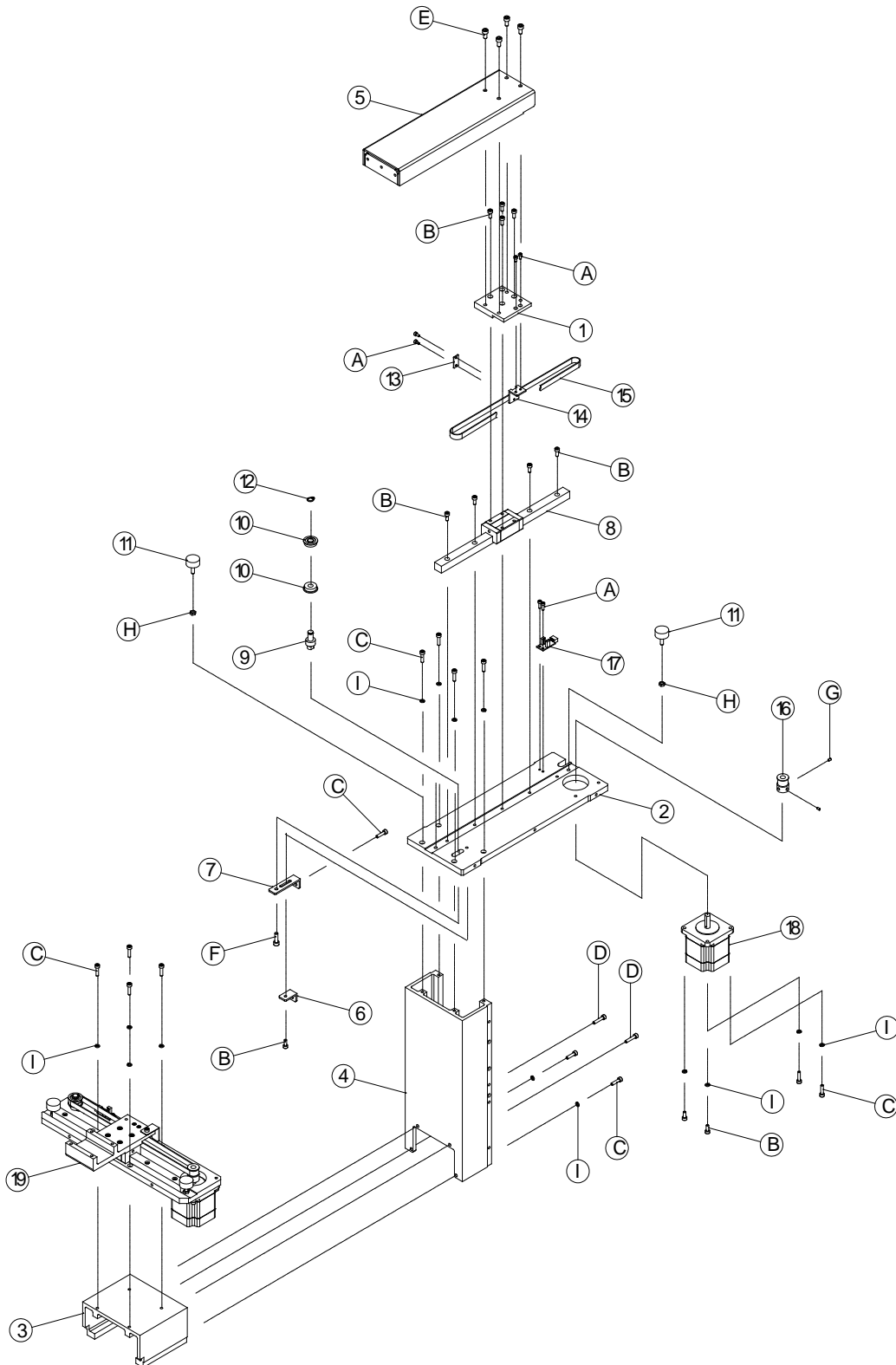

F4200N.2 – Y Axis Part List

NO.	PART NO.	ENGLISH NAME
1	1212-10102002	Y SLIDING PLATE
2	1212-10105001	Y FIXING PLATE
3	1212-10114001	X MOUNTING BRACKET
4	1212-10115001	BODY CASE
5	1212-10220001	Y SLIDING CARRIAGE
6	1212-10230002	TIMING BELT ADJUSTING KIT
7	1212-10230003	TIMING BELT ADJUSTING KIT BASE
8	1212-10303001	LM GUIDE
9	0603-20150001	X/Y IDLE PULLEY
10	0603-20304001	BEARING
11	0603-20400001	BUFFER PILLAR
12	0603-20400003	C CLIP
13	0607-10220001	TIMING BELT FIXING PLATE
14	0607-10230001	TIMING BELT FIXING KIT
15	0607-10309001	Y TIMING BELT
16	0711-10308001	X/Y/Z TIMING PULLEY (MOTOR SIDE)
17	A08DCW-0603-2-P103	OPTICAL LIMIT SWITCH
18	A21MOTOR-EH366-38	3-PHASE STEP MOTOR
19	1212-15100001	X AXIS MODULE
A	W113000004	ALLOY HEXAGONAL SOCKET BOLT 牛M3*5L 犬
B	W113000005	ALLOY HEXAGONAL SOCKET BOLT 牛M3*10L 犬
C	W113000011	ALLOY HEXAGONAL SOCKET BOLT 牛M4*10L 犬
D	W113000012	ALLOY HEXAGONAL SOCKET BOLT 牛M4*15L 犬
E	W113000013	ALLOY HEXAGONAL SOCKET BOLT 牛M4*20L 犬
F	W113000059	ALLOY SET BOLT 牛M3*5L 犬
G	W116000013	SUS HEXAGONAL SOCKET BOLT 牛M4*5L 犬
H	W116000038	SUS BIND SCREW 牛M3*10L 犬
I	W118000010	SUS SPRING WASHER 牛M4 犬
J	W118000003	SUS FLAT WASHER 牛M4 犬

F4200N.2 – Z Axis Drawing

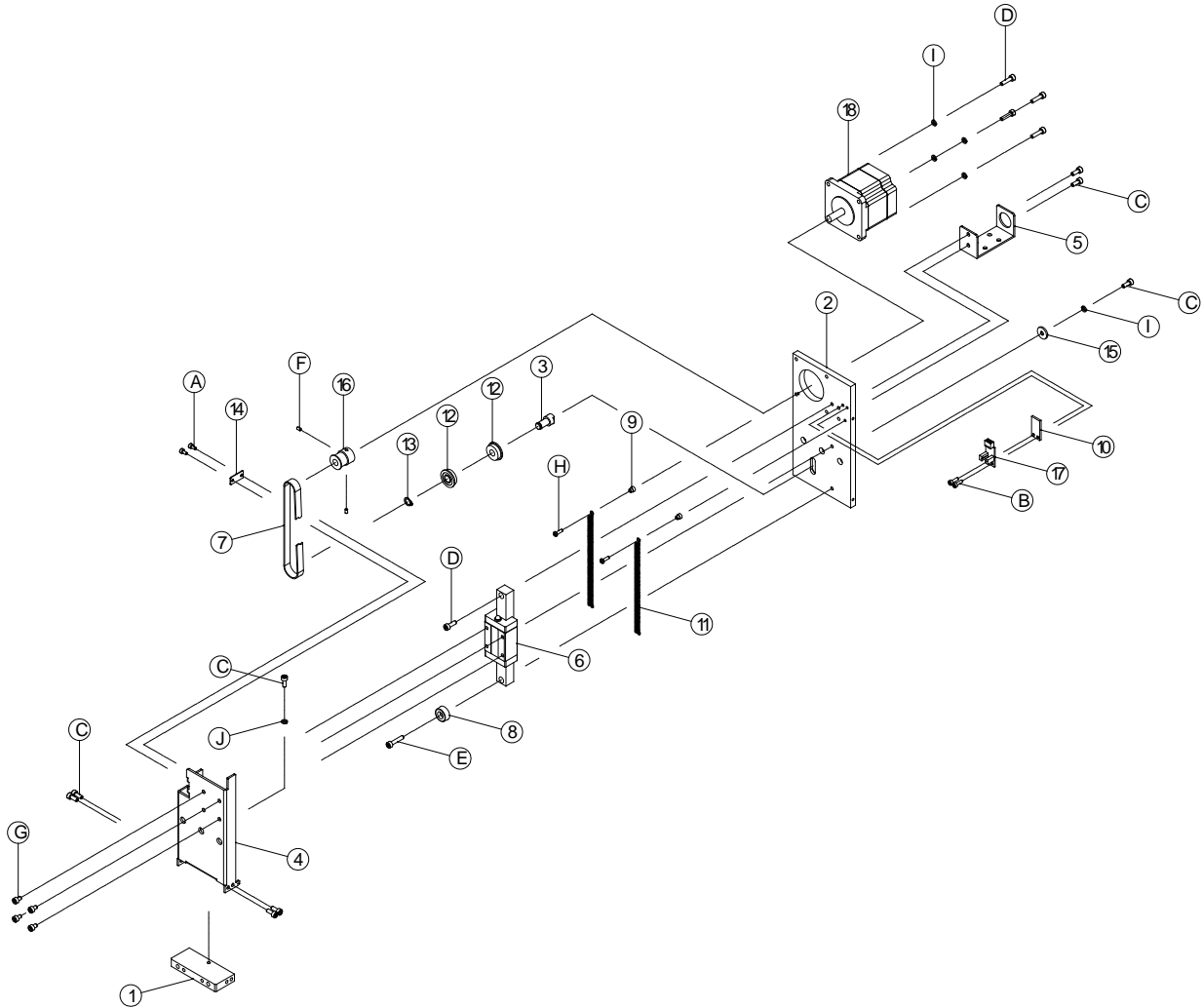

F4200N.2 – Z Axis Part List

NO.	PART NO.	ENGLISH NAME
1	1212-10100001	Z TOOLING BASE
2	1212-10102003	Z FIXING PLATE
3	1212-10150001	Z IDLE PULLEY
4	1212-10220002	Z SLIDING PLATE
5	1212-10230004	Z PIPE HOLDER
6	1212-10303002	LM GUIDE
7	1212-10309001	Z TIMING BELT
8	1212-10400001	CUSHION
9	0505-20150001	SPRING TUBE-SHAPED
10	0505-20160001	OPTICAL LIMIT SWITCH WASHER
11	0505-20306001	SPRING
12	0603-20304001	BEARING
13	0603-20400003	C CLIP
14	0607-10220001	TIMING BELT FIXING PLATE
15	0711-10220001	PULLEY FIXING PLATE
16	0711-10308001	X/Y/Z TIMING PULLEY (MOTOR SIDE)
17	A08DCW-0603-2-P103	OPTICAL LIMIT SWITCH
18	A21MOTOR-EH366-38	3-PHASE STEP MOTOR
A	W113000004	ALLOY HEXAGONAL SOCKET BOLT 牛M3*5L 犬
B	W113000005	ALLOY HEXAGONAL SOCKET BOLT 牛M3*10L 犬
C	W113000011	ALLOY HEXAGONAL SOCKET BOLT 牛M4*10L 犬
D	W113000012	ALLOY HEXAGONAL SOCKET BOLT 牛M4*15L 犬
E	W113000013	ALLOY HEXAGONAL SOCKET BOLT 牛M4*20L 犬
F	W113000059	ALLOY SET BOLT 牛M3*5L 犬
G	W116000013	SUS HEXAGONAL SOCKET BOLT 牛M4*5L 犬
H	W116000038	SUS BIND SCREW 牛M3*10L 犬
I	W118000010	SUS SPRING WASHER 牛M4 犬
J	W118000003	SUS FLAT WASHER 牛M4 犬

Electrical Part Lists F4200N.2

F4200N.2 Electrical Drawing #1

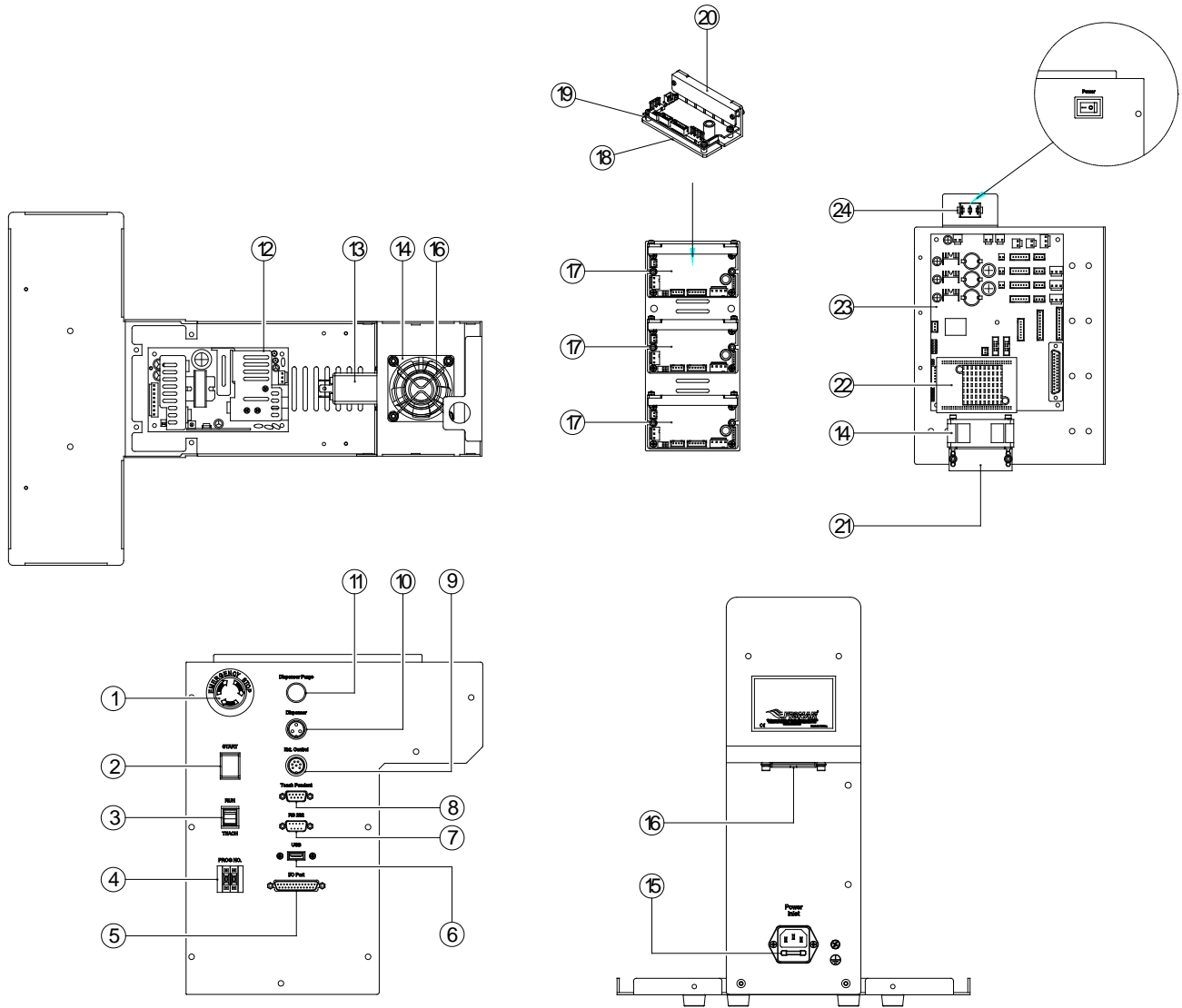

F4200N.2 Electrical Drawing #1 Part List

NO.	PART NO.	DESCRIPTION
1	A08PSW-A165ES01R	EMERGENCY STOP BUTTON (OMRON)
2	A08SWOT-D16LMT2R	GREEN START BUTTON
3	A08RSW-WR1031WR6R2SR	RUN TEACH MODE SWITCH
4	A08PSW-PS3110911R A08SWOT-PS31-COVER	PROGRAM NUMBER SWITCH PROGRAM NUMBER SWITCH FRAME
5	A09WP-1212-1-W13	I/O SIGNAL WIRE(D50P)
6	A09WOT-USB560MM	USB PORT MODULE
7	A09WP-0801-2-W23	RS-232 CONNECTOR
8	A09WP-1212-2-W14	TEACH PENDANT SIGNAL WIRE
9	A09WP-0505-2-W14	EXT. CONTROL CONNECTOR
10	A09WP-1212-1-W12	DISPENSER SIGNAL & DISPENSER PURGE WIRE
11	A08PSW-D16LMR1+BS04	DISPENSER PURGE BUTTON
12	A23POW-EPP-400-24R	POWER SUPPLY
13	A24EQ-CW2A-06A-T	2 IN 1 FILTER+FUSE BOX
14	A19FAN-KDE1206PTV1RA	FAN-30CM
15	A22FUSE-3-250R	FUSE
16	A19FAN-B9	FAN PROTECTIVE NET 6*6 CM
17	A13AC-SR1300-DVA	3-PHASE DRIVER CARD
18	1211-10200003	3-PHASE DRIVER HEAT SINK PANEL
19	1211-10150001	3-PHASE DRIVER BOLSTER
20	1211-10230002	3-PHASE DRIVER CLAMPING PLATE
21	0603-20230006	FAN FOOT
22	A19PCOR-F4303N	PC CARD
23	A13AC-SR1300-7CTA	CONTROL BOARD
24	A08RSW-RL3311NGRRP4	POWER SWITCH

F4200N.2 Electrical Drawing #2

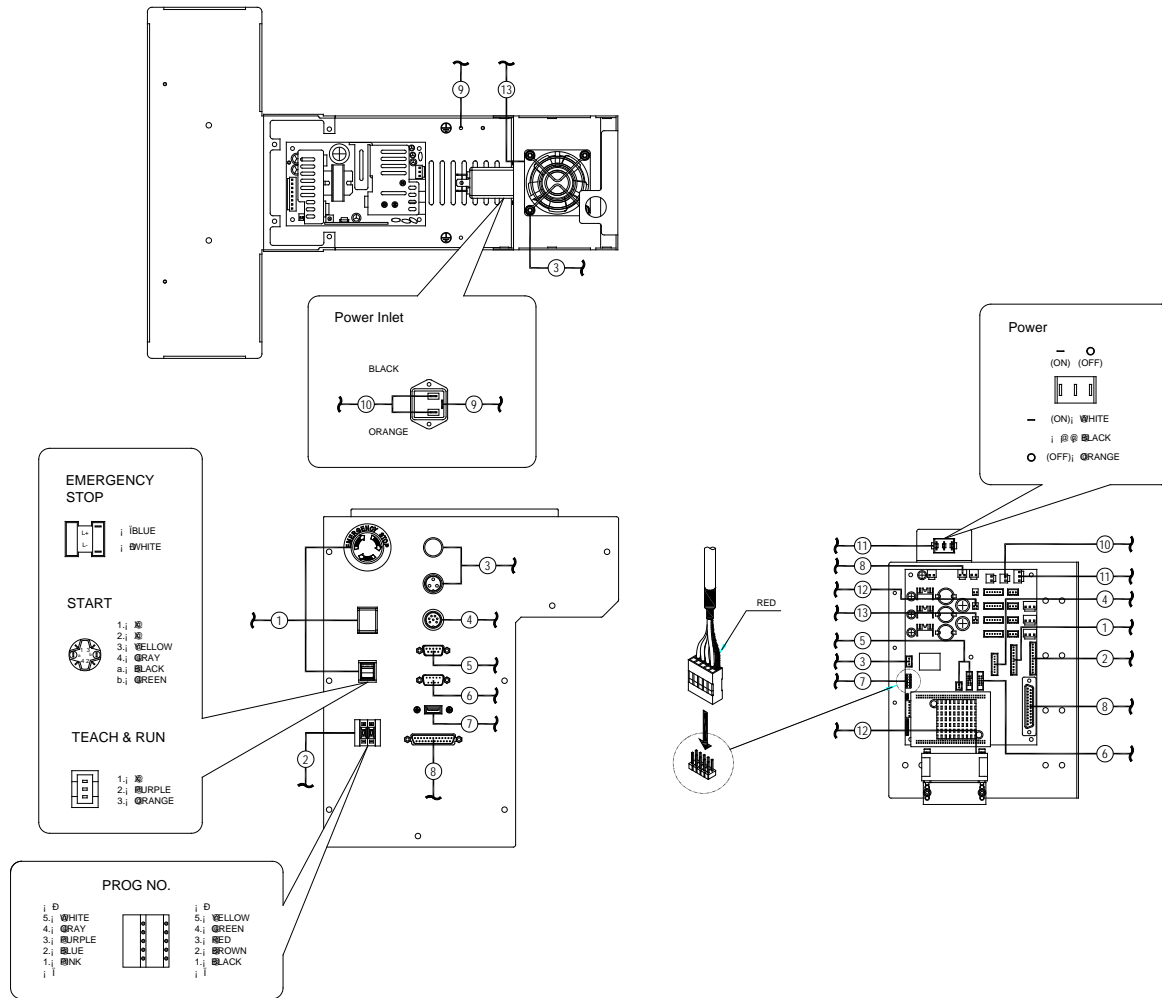

F4200N.2 Electrical Drawing #2 Part List

NO.	PART NO.	DESCRIPTION
1	A09WP-1212-1-W11	CONTROL PANEL SIGNAL CONVERGE WIRE
2	A09WP-0603-2-W18	PROGRAM NUMBER SWITCH WIRE
3	A09WP-1212-1-W12	DISPENSER SIGNAL & DISPENSER PURGE WIRE
4	A09WP-0505-2-W14	EXT. CONTROL CONNECTOR
5	A09WP-1212-2-W14	TEACH PENDANT SIGNAL WIRE
6	A09WP-0801-2-W23	RS-232 CONNECTOR
7	A09WOT-USB560MM	USB PORT MODULE
8	A09WP-1212-1-W13	I/O SIGNAL WIRE(25P)
9	A09WP-0505-2-W18	POWER INPUT GROUND WIRE
10	A09WP-0603-3-W14	FN4_AC INPUT WIRE
11	A09WP-1212-1-W09	AC SWITCH POWER WIRE
12	A19FAN-KDE1206PTV1RA	FAN-30CM
13	A19FAN-KDE1206PTV1RA	FAN-30CM

F4200N.2 Electrical Drawing #3

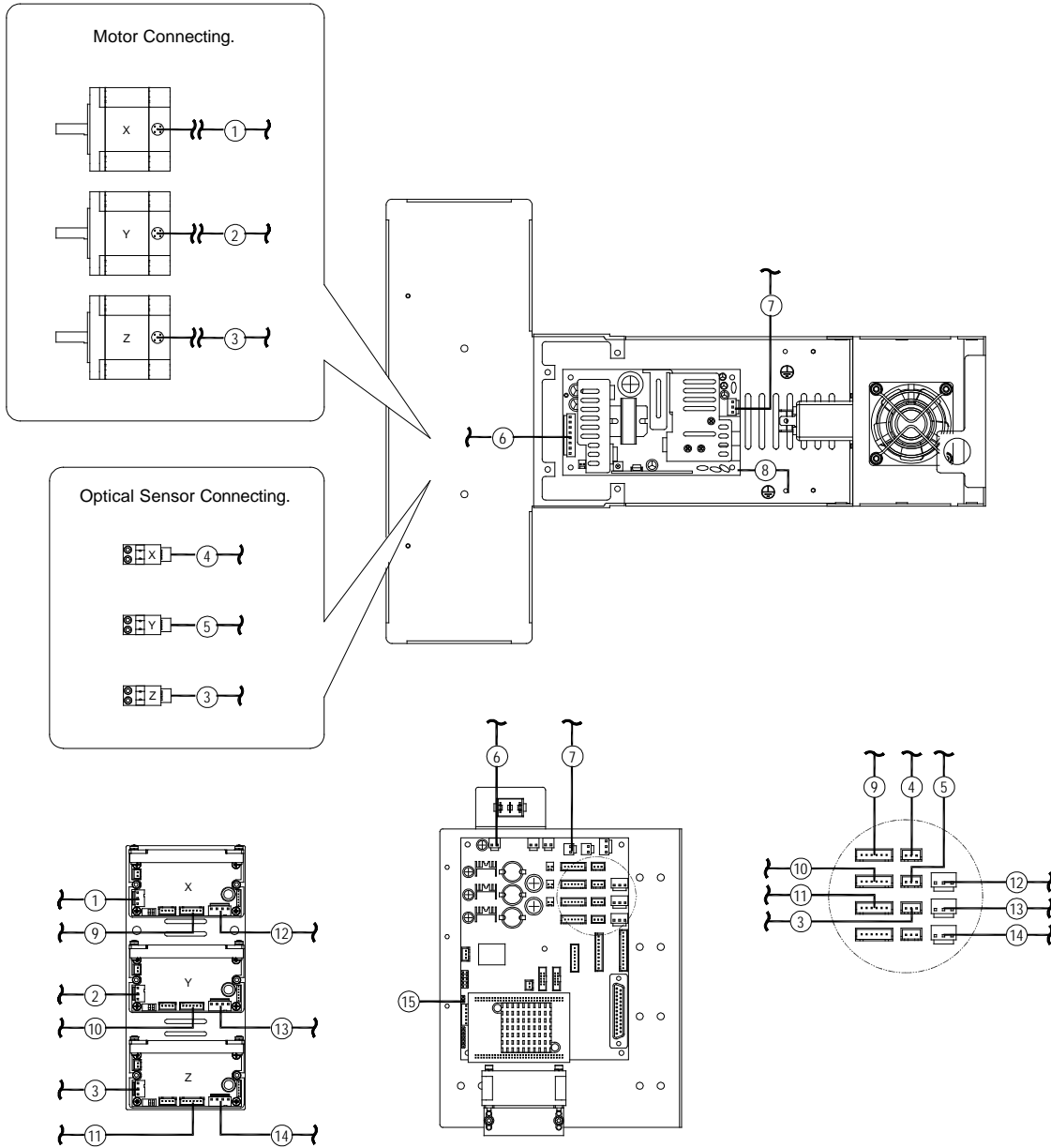

F4200N.2 Electrical Drawing #3 Part List

NO.	PART NO.	DESCRIPTION
1	A09WP-1212-1-W02	X AXIS MOTOR WIRE
2	A09WP-1212-1-W03	Y AXIS MOTOR WIRE
3	A09WP-1212-1-W01	Z AXIS PIPE MODULE
4	A09WP-1212-1-W04	X OPTICAL SENSOR WIRE
5	A09WP-0505-2-W07	Y OPTICAL SENSOR WIRE
6	A09WP-1212-1-W10	24V DC POWER WIRE
7	A09WP-0607-1-W03	LF9_24V AC INPUT WIRE
8	A09WP-0607-1-W26	LF9_ POWER GROUND WIRE
9	A09WP-1212-1-W06	DRIVER SIGNAL WIRE 350-X AXIS
10	A09WP-1212-1-W07	DRIVER SIGNAL WIRE 400-Y AXIS
11	A09WP-1212-1-W08	DRIVER SIGNAL WIRE 480-Z AXIS
12	A09WP-0607-1-W23	LF9_X AXIS MOTOR DRIVER POWER WIRE
13	A09WP-0505-2-W10	XYZ MOTOR DRIVER POWER WIRE-Y AXIS
14	A09WP-1212-1-W05	Z DRIVER POWER WIRE
15	A19SPEAK-BUZZER	BUZZER

THIS PAGE INTENTIONALLY LEFT BLANK

